



# Xpressnap® Countertop Dispenser N4 System



## Loading Instructions

*Instrucciones de Recarga*

*Instructions de Remplissage*

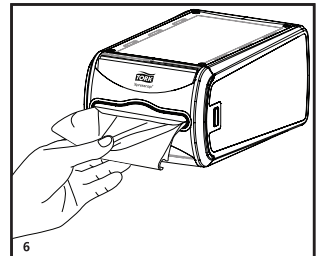
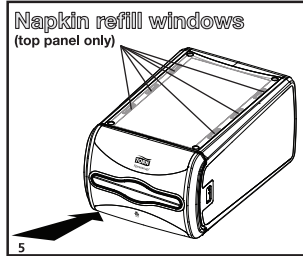
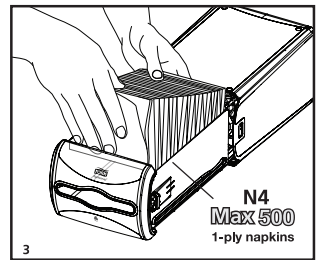
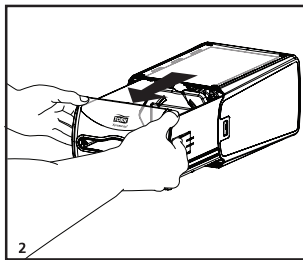
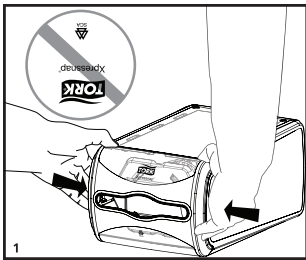

## Cleaning Instructions

*Instrucciones de Limpieza*

*Instructions de Nettoyage*

**Cleaning:** Use mild cleaners. Wipe with cloth using soap and water. Do not use abrasives. Dispenser is not dishwasher safe. Dispenser's mouth can be disassembled for cleaning, if necessary.

**Limpieza:** use limpiadores suaves. Frote con un paño, con agua y jabón. No use abrasivos. El dispensador no es apto para lavar en máquinas lavavajillas. La boca del dispensador puede desmontarse para la limpieza, si fuera necesario.

**Nettoyage:** Utiliser des produits nettoyants doux. Essuyer avec un tissu mouillé d'eau et de savon. Ne pas utiliser de produit abrasif. Le distributeur n'est pas conçu pour aller au lave-vaisselle. Si nécessaire, le bec du distributeur peut être démonté pour être nettoyé.



# Xpressnap® Countertop Dispenser N4 System



## AD-a-Glance® Feature

*Espacio Publicitario Para AD-a-Glance*

*Fonction AD-a-Glance*

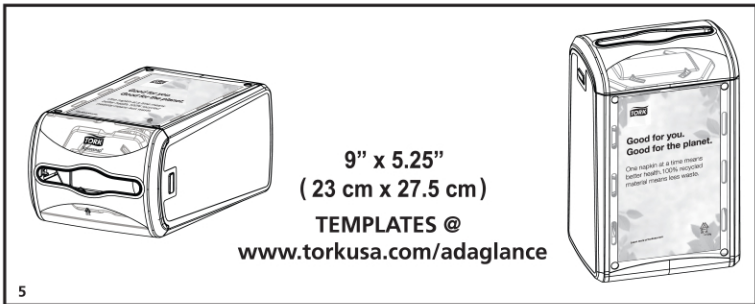
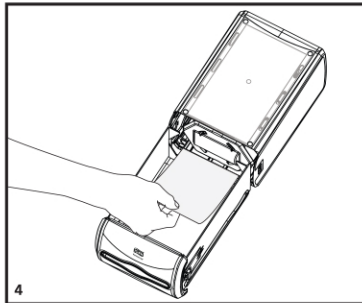
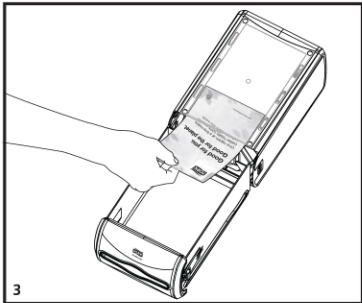
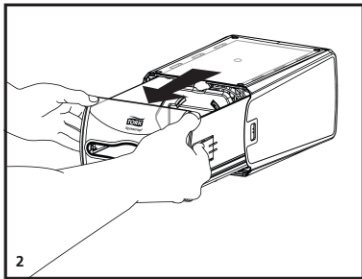
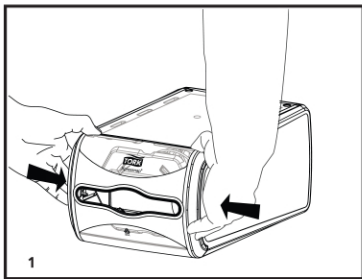

9" x 5.25"  
(23 cm x 27.5 cm)

TEMPLATES @  
[www.torkusa.com/adaglance](http://www.torkusa.com/adaglance)