

58008B

SofPull® Centerpull Junior Towel Dispenser

(Side B - Optional Mounting
Bracket Instruction)

- 1** Tape template to wall and use drill to make pilot holes | Pegue la plantilla a la pared con cinta adhesiva y use un taladro para hacer orificios guía. | Fixer le gabarit au mur avec du ruban adhésif et percer des trous de guidage à l'aide d'une perceuse

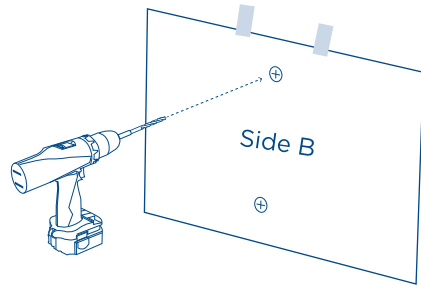

- 2** Use proper mounting hardware to install wall bracket against the wall | Use los accesorios de montaje para instalar el soporte en la pared. | Utiliser des éléments de fixation adaptés pour installer le support mural contre le mur

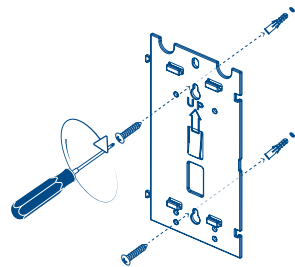

- 3** Align holes on dispenser to bracket hooks and attach dispenser to the bracket. | Alinee los orificios del dispensador con los ganchos del soporte y cuelgue el dispensador al soporte. | Aligner les trous du distributeur sur les crochets du support et fixer le distributeur au support

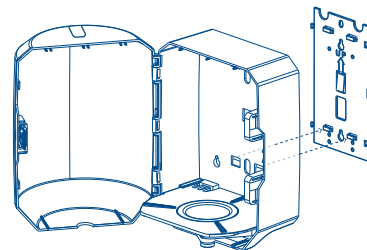

- 4** Fill and close dispenser cover to finish | Cargue el dispensador y cierre la tapa para terminar. | Placer la recharge et fermer le couvercle du distributeur

B
Hinge side, Door needs 5" clearance | Lado de las bisagras. La puerta necesita disponer de un espacio libre de 12.5 cm | Prévoir un dégagement de 5" (12,7 cm) par rapport aux charnières pour l'ouverture

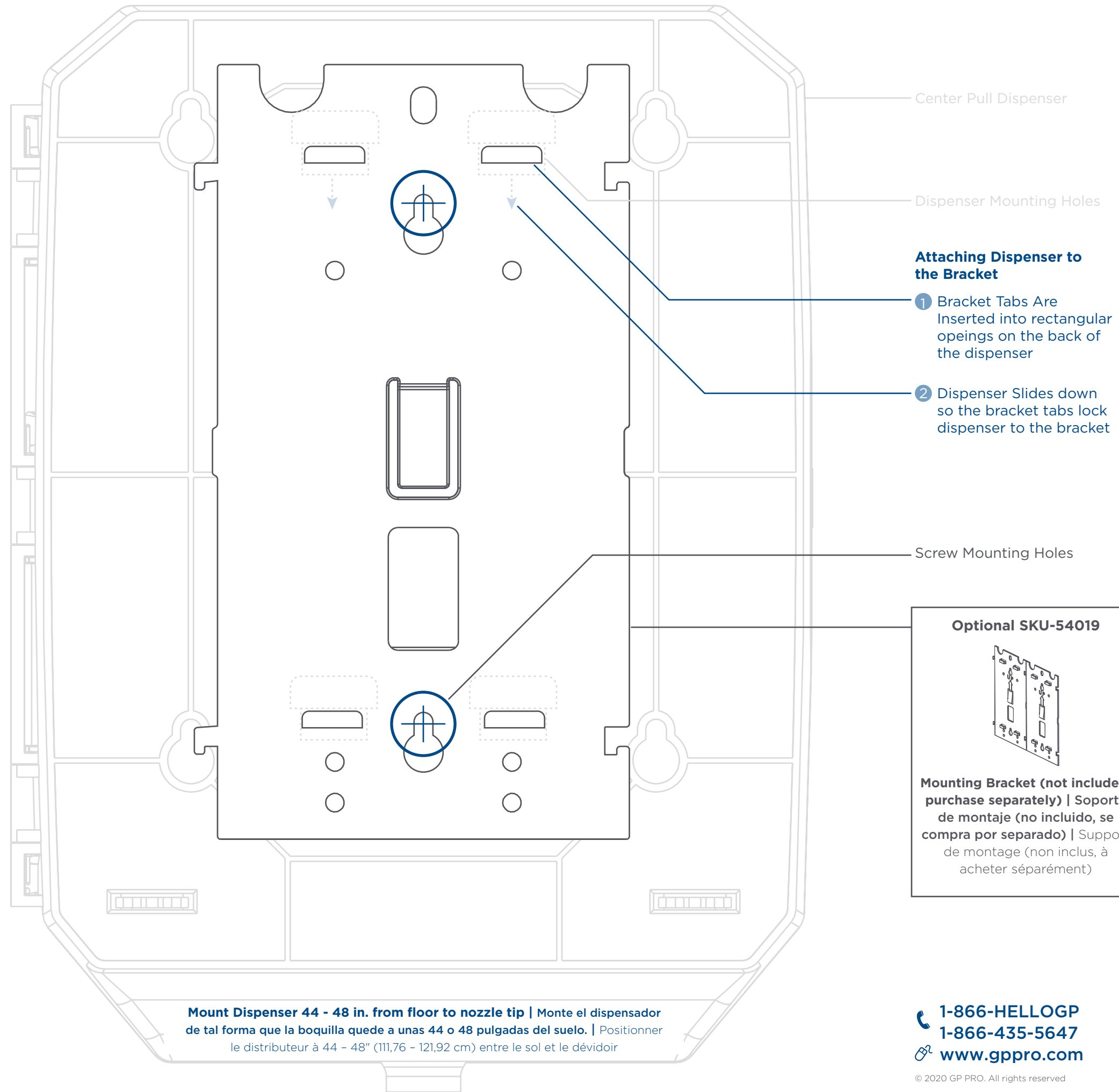

Tape Paper Template To Wall For Placement | Pegue la plantilla de papel en la pared para situar el dispensador. | Gabarit en papier adhésif à placer au mur

1-866-HELLOGP
1-866-435-5647
www.gppro.com

© 2020 GP PRO. All rights reserved

58008B

SofPull® Centerpull Junior Towel Dispenser

(Side A - Mounting Dispenser
Directly to the Wall)

A

- 1** Tape template to wall and use drill to make pilot holes | Pegue la plantilla a la pared con cinta adhesiva y use un taladro para hacer orificios guía. | Fixer le gabarit au mur avec du ruban adhésif et percer des trous de guidage à l'aide d'une perceuse

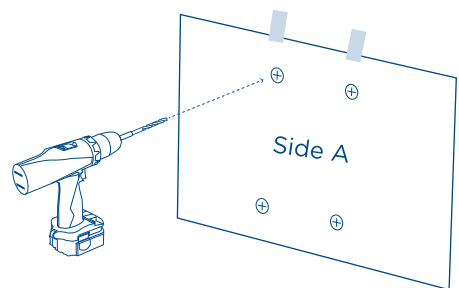

- 2** Use proper mounting hardware to install dispenser against the wall | Use los accesorios de montaje para instalar el dispensador en la pared. | Utiliser des éléments de fixation adaptés pour installer le distributeur contre le mur

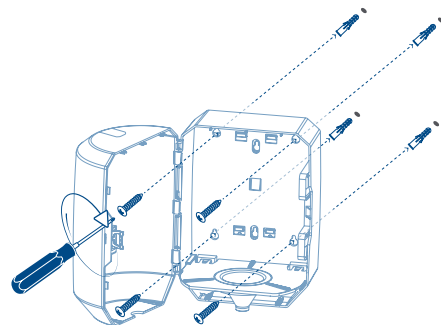

- 3** Follow loading instructions on inside cover, load and then close dispenser | Siga las instrucciones que aparecen en el interior de la tapa para cargar el dispensador y luego ciérrelo. | Suivre les instructions de chargement figurant à l'intérieur du couvercle, placer la recharge puis fermer le distributeur

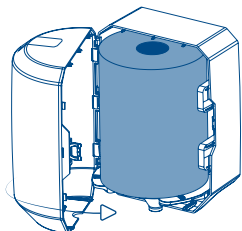

Hinge side, Door needs 5" clearance | Lado de las bisagras. La puerta necesita disponer de un espacio libre de 12.5 cm | Prévoir un dégagement de 5" (12,7 cm) par rapport aux charnières pour l'ouverture



Important Installation Instructions

For easy installation this sheet can be used as a mounting template

Wooden Walls

Use 5/8" No.8 R. H. Wood Screws

Concrete, Brick, Marble, or Tile Walls

Use 1" No. 8 Plastic Anchors with No. 8 Pan Head Self-Tapping Screws

Plaster Walls

Use 3/16" x 3" Toggle Bolts

Steel Partitions

Use 5/8" No. 8 Pan Head Sheet Metal Screws

Mount Dispenser 44 - 48 in. from floor to nozzle tip | Monte el dispensador de tal forma que la boquilla quede a unas 44 o 48 pulgadas del suelo. | Positionner le distributeur à 44 - 48" (111,76 - 121,92 cm) entre le sol et le dévidoir

You Will Need | Usted necesitará |
Ce dont vous aurez besoin

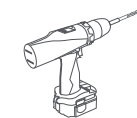

Power Drill | Taladro eléctrico | Perceuse électrique



Screwdriver | Destornillador | Tournevis



x4 - Screws | Tornillos | Vis



Tape Measure | Cinta métrica | Ruban à mesurer



Tape | Cinta | Ruban adhésif

Optional | Opcional | Optionnel



x4 - Wall Anchors | Anclajes de pared | Ancrages muraux



Marker | Marcador | Outil de marquage

What Is In The Box | Qué hay en la caja | Contenu de la boîte

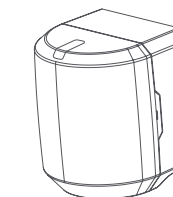

Dispenser | Dispensador | Distributeur



Key | Llave | Clé



Registration/Warranty | Registro/Garantía | Enregistrement/Garantie



Installation Template | Plantilla de instalación | Gabarit d'installation



1-866-HELLOGP
1-866-435-5647

www.gppro.com

PRT - 0000001121 - REV A
© 2020 GP PRO. All rights reserved