



2021
PRODUCT
CATALOG



2021 PRODUCT CATALOG TABLE OF CONTENTS

INNOBOX EDGE™ & Inserts	3-6 Pizza Cartons	41-42 INNOPAK VISIONS™ Cartons	67-68 LDPE Bread & Roll Bags	87-90
Compostable INNOBOX EDGE™	7-8 Snap Sheets	43-44 INNOPAK VISIONS™	Beverage & Bottle Carriers	91-92
Plain White Deli Cartons	9-10 Handled Paper Carryout Bags	45-48 Cake Cartons	69-70 Ice Bags	93-94
Soup Cups & Lids	11-17 Handle Cuffs	49-50 Cupcake & Muffin	reBags™	95-96
Buckets & Lids	18-20 Meal Solutions Carryout Bags	51-54 Rigid PET Containers	71-72 Corrugated Carryout Cartons	97
Rigid Clamshell Containers	21-23 Deli Bags	55-56 Fresh Flavor™ Bakery	73-78 About Inno-Pak	98-99
Rigid 2-Piece Containers	24-26 Seafood Bags	57-58 Donut & Specialty Cartons: 74, 75,		
Molded Fiber Containers & Lids	27-32 Crystal Clear	Cake Cartons: 74, 76, Pie Cartons: 74, 75,		
Fresh Flavor™ Carryout	33-40 Sub & Sandwich Bags	Wax & Paper Bread Bags: 77,		
Carryout Cartons: 34, Soup Cups: 34-36,	Rotisserie & Fried Chicken Bags	PP/HDPE Bags & Bag Racks: 78		
Buckets: 36-38, Deli Bags: 38-39,	Produce Bags	59-60 Corrugated Circles & Pads	79-81	
Meal Solutions Carryout Bags: 39,	Cookie Bags	61-62 Crystal Clear Bread & Roll Bags	82-84	
Rotisserie & Fried Chicken Bags: 40		63-64 Micro-Perf Bread & Roll Bags	85-86	

CUSTOMER CARE

Phone: 1-800-InnoPak
 E-mail: info@innopak.com
 Hours: 8:00am to 5:00pm EST
 Monday - Friday

SALES: REGIONAL VICE PRESIDENTS

<p>MIDWEST</p> <p>Nicholas Healey - Midwest (740) 203-2516 nicholas@innopak.com</p>	<p>CENTRAL</p> <p>Brian Zapior - Central (740) 815-9055 brian@innopak.com</p>	<p>MID-ATLANTIC</p> <p>Adam Bechtold - Mid-Atlantic (740) 203-2503 adam@innopak.com</p>	<p>NORTHEAST</p> <p>Brian Masi - Northeast (740) 203-2518 brianm@innopak.com</p>
<p>WEST</p> <p>Bill Welmon - West (740) 203-2521 bwelmon@innopak.com</p>	<p>SOUTHWEST</p> <p>Ed Von Doersten - Southwest (740) 203-2517 ed@innopak.com</p>	<p>SOUTHEAST</p> <p>Bob Loblein - Southeast (740) 203-2515 bob@innopak.com</p>	<p>EVP NATIONAL ACCOUNTS</p> <p>Chris Sanzone (740) 363-0090 ext. 106 csanzone@innopak.com</p>
<p>STRATEGIC ACCOUNTS</p> <p>Nathan Sill (740) 361-5078 nate@innopak.com</p>	<p>NATIONAL ACCOUNTS</p> <p>Paul Di Trapani (248) 789-3085 pauld@innopak.com</p>	<p>NATIONAL ACCOUNTS</p> <p>Brian Hughes (740) 203-2538 bhughes@innopak.com</p>	<p>NATIONAL ACCOUNTS</p> <p>Ed Kanya (740) 363-0090 ext. 152 ekanya@innopak.com</p>



- ◆ Available in Plain Kraft, White SBS, and Black SBS
- ◆ Inner poly lining combined with our unique inset fold means stronger corners with great leak protection
- ◆ Patented innovative reverse lock closure eliminates the need to tape or rubber-band the cartons (*Patent D777,029*)
- ◆ New tear-away flaps for a better consumer experience (*Patent D876,951*)
- ◆ Cartons are nested for easy setup and come in optimized case packs for shipping, storage, and handling efficiency
- ◆ Heat sealed inset corners eliminate the need for glue
- ◆ **CUSTOM PRINT PROGRAM:** Customize eligible items with your brand and design (up to 8 colors)
- ◆ Low minimum custom print runs with 12 week lead time from receipt of approved artwork

Hot Food Friendly
 Cold Food Friendly

Leak Resistant
 Microwavable

Custom Printing
 Heat Sealed

Recyclable Item*
* If clean and dry
 Check with your local municipality/store
 Remove window prior to recycling

WHY CHOOSE INNOBOX EDGE™?

INNOBOX EDGE™ ADVANTAGE

Heat sealed inset corners eliminate the need for glue, and the unique inset fold means stronger corners with greater leak protection.

- ◆ Inset corner fold creates a streamlined edge and strong corners
- ◆ The corner is heat sealed on the inside, away from sight

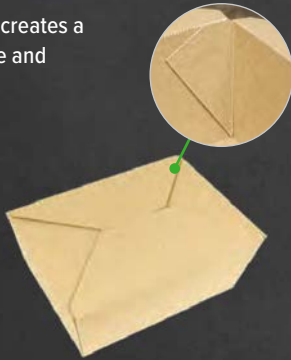

PERF-ECTION: TEAR-AWAY FLAPS!*

For a better dining experience, make all sizes of the INNOBOX EDGE™ into a food tray in four easy tears.

- ◆ Specially designed perforation pattern
- ◆ All flaps easily tear away
- ◆ The INNOBOX EDGE™ becomes a food tray



THE MOST SECURE CLOSURE

The patented* Reverse Lock Closure keeps the INNOBOX closed eliminating the need to tape or rubber band the carton.



INNOBOX EDGE™ - PLAIN KRAFT



#1 INNOBOX EDGE™ - Plain Kraft 194830225 – Stock

◆ CUSTOM PRINT PROGRAM MIN: 30,000

Capacity: 22 Fluid oz.

Material: Kraft, Poly Coated Inside

Description: Pre-Formed, Nested, Leak Resistant

Size: 4.375" x 3.562" x 2.5"

Case Pack: 180/case

Dim: 23.2" x 13.9" x 5.7" – Wgt: 9 lbs.

Cube: 1.06 – TI/Hi: 09/08

UPC: 842644029012



#2 INNOBOX EDGE™ - Plain Kraft 197945346 – Stock

◆ CUSTOM PRINT PROGRAM MIN: 30,000

Capacity: 36 Fluid oz.

Material: Kraft, Poly Coated Inside

Description: Pre-Formed, Nested, Leak Resistant

Size: 7.75" x 5.5" x 1.875"

Case Pack: 140/case

Dim: 21.8" x 9.4" x 13.5" – Wgt: 11.8 lbs.

Cube: 1.60 – TI/Hi: 09/03

UPC: 842644028978



#3 INNOBOX EDGE™ - Plain Kraft 192738969 – Stock

◆ CUSTOM PRINT PROGRAM MIN: 30,000

Capacity: 56 Fluid oz.

Material: Kraft, Poly Coated Inside

Description: Pre-Formed, Nested, Leak Resistant

Size: 7.75" x 5.5" x 2.5"

Case Pack: 130/case

Dim: 21.8" x 9.4" x 13.5" – Wgt: 13.6 lbs.

Cube: 1.60 – TI/Hi: 09/03

UPC: 842644028923



INNOBOX EDGE™ - PLAIN KRAFT



#4 INNOBOX EDGE™ - Plain Kraft 192045724 – Stock

◆ CUSTOM PRINT PROGRAM MIN: 30,000

Capacity: 75 Fluid oz.

Material: Kraft, Poly Coated Inside

Description: Pre-Formed, Nested, Leak Resistant

Size: 7.75" x 5.5" x 3.5"

Case Pack: 90/case

Dim: 21.8" x 9.4" x 13.5" – Wgt: 12.2 lbs.

Cube: 1.60 – TI/Hi: 09/03

UPC: 842644028886



#8 INNOBOX EDGE™ - Plain Kraft 191368623 – Stock

◆ CUSTOM PRINT PROGRAM MIN: 30,000

Capacity: 29 Fluid oz.

Material: Kraft, Poly Coated Inside

Description: Pre-Formed, Nested, Leak Resistant

Size: 6" x 4.75" x 2.5"

Case Pack: 130/case

Dim: 24.1" x 7.5" x 11.6" – Wgt: 9.8 lbs.

Cube: 1.21 – TI/Hi: 10/04

UPC: 842644028985



INNOBOX EDGE™ - WHITE SBS



#1 INNOBOX EDGE™ - White SBS 194488677 – Stock

◆ CUSTOM PRINT PROGRAM MIN: 30,000

Capacity: 22 Fluid oz.

Material: SBS, Poly Coated Inside

Desc: Pre-Formed, Nested, Leak Resistant

Size: 4.375" x 3.562" x 2.5"

Case Pack: 180/case

Dim: 23.2" x 13.9" x 5.7" – Wgt: 9.4 lbs.

Cube: 1.06 – TI/Hi: 06/08

UPC: 842644029029



INNOBOX EDGE™ - WHITE SBS



#2 INNOBOX EDGE™ - White SBS 194101606 – Stock

♦ CUSTOM PRINT PROGRAM MIN: 30,000

Capacity: 36 Fluid oz.
Material: SBS, Poly Coated Inside
Description: Pre-Formed, Nested, Leak Resistant
Size: 7.75" x 5.5" x 1.875"
Case Pack: 140/case
Dim: 21.8" x 9.4" x 13.5" – Wgt: 12.4 lbs.
Cube: 1.67 – TI/HI: 09/03
UPC: 842644028909



#3 INNOBOX EDGE™ - White SBS 197684177 – Stock

♦ CUSTOM PRINT PROGRAM MIN: 30,000

Capacity: 56 Fluid oz.
Material: SBS, Poly Coated Inside
Description: Pre-Formed, Nested, Leak Resistant
Size: 7.75" x 5.5" x 2.5"
Case Pack: 130/case
Dim: 21.8" x 9.4" x 13.5" – Wgt: 11.2 lbs.
Cube: 1.60 – TI/HI: 09/03
UPC: 842644028900



#4 INNOBOX EDGE™ - White SBS 197474329 – Stock

♦ CUSTOM PRINT PROGRAM MIN: 30,000

Capacity: 75 Fluid oz.
Material: SBS, Poly Coated Inside
Description: Pre-Formed, Nested, Leak Resistant
Size: 7.75" x 5.5" x 3.5"
Case Pack: 90/case
Dim: 21.8" x 9.4" x 13.5" – Wgt: 12.8 lbs.
Cube: 1.60 – TI/HI: 09/03
UPC: 842644028947



INNOBOX EDGE™ - WHITE SBS



#8 INNOBOX EDGE™ - White SBS 195421255 – Stock

♦ CUSTOM PRINT PROGRAM MIN: 30,000

Capacity: 29 Fluid oz.
Material: SBS, Poly Coated Inside
Description: Pre-Formed, Nested, Leak Resistant
Size: 6" x 4.75" x 2.5"
Case Pack: 130/case
Dim: 24.1" x 7.5" x 11.6" – Wgt: 8.8 lbs.
Cube: 1.21 – TI/HI: 10/04
UPC: 842644028992



INNOBOX EDGE™ - BLACK SBS



#1 INNOBOX EDGE™ - Black SBS 194544528 – Stock

♦ CUSTOM PRINT PROGRAM MIN: 30,000

Capacity: 22 Fluid oz.
Material: SBS, Poly Coated Inside
Description: Pre-Formed, Nested, Leak Resistant
Size: 4.375" x 3.562" x 2.5"
Case Pack: 180/case
Dim: 23.2" x 13.9" x 5.7" – Wgt: 9.4 lbs.
Cube: 1.06 – TI/HI: 06/08
UPC: 842644028905



#2 INNOBOX EDGE™ - Black SBS 191552922 – Stock

♦ CUSTOM PRINT PROGRAM MIN: 30,000

Capacity: 36 Fluid oz.
Material: SBS, Poly Coated Inside
Description: Pre-Formed, Nested, Leak Resistant
Size: 7.75" x 5.5" x 1.875"
Case Pack: 140/case
Dim: 21.8" x 9.4" x 13.5" – Wgt: 11.2 lbs.
Cube: 1.60 – TI/HI: 09/03
UPC: 842644028961



INNOBOX EDGE™ - WHITE SBS



#3 INNOBOX EDGE™ - Black SBS 194369396 – Stock

♦ CUSTOM PRINT PROGRAM MIN: 30,000

Capacity: 56 Fluid oz.
Material: SBS, Poly Coated Inside
Description: Pre-Formed, Nested, Leak Resistant
Size: 7.75" x 5.5" x 2.5"
Case Pack: 130/case
Dim: 21.8" x 9.4" x 13.5" – Wgt: 11.4 lbs.
Cube: 1.60 – TI/HI: 09/03
UPC: 842644028916



#4 INNOBOX EDGE™ - Black SBS 194408305 – Stock

♦ CUSTOM PRINT PROGRAM MIN: 30,000

Capacity: 75 Fluid oz.
Material: SBS, Poly Coated Inside
Description: Pre-Formed, Nested, Leak Resistant
Size: 7.75" x 5.5" x 3.5"
Case Pack: 90/case
Dim: 21.8" x 9.4" x 13.5" – Wgt: 12.8 lbs.
Cube: 1.60 – TI/HI: 09/03
UPC: 842644028893



#8 INNOBOX EDGE™ - Black SBS 196259595 – Stock

♦ CUSTOM PRINT PROGRAM MIN: 30,000

Capacity: 29 Fluid oz.
Material: SBS, Poly Coated Inside
Description: Pre-Formed, Nested, Leak Resistant
Size: 6" x 4.75" x 2.5"
Case Pack: 130/case
Dim: 24.1" x 7.5" x 11.6" – Wgt: 8.8 lbs.
Cube: 1.21 – TI/HI: 10/04
UPC: 842644028954



PROVIDE A CLEAR VIEW!

- ◆ Windowed INNOBOX EDGE™ cartons available in #3 and #8
- ◆ Fully nested for easy setup and storage
- ◆ **CUSTOM PRINT PROGRAM:** Customize eligible items with your brand and design (up to 6 colors)
- ◆ Low minimum custom print runs with 12 week lead time from receipt of approved artwork

INNOBOX EDGE™ - WINDOWED KRAFT



#3 Windowed INNOBOX EDGE™ - Plain Kraft 196712750 – Stock

◆ **CUSTOM PRINT PROGRAM MIN: 25,000 pcs.**

Capacity: 56 Fluid oz.
Material: Kraft, Poly Coated Inside
Description: Tuck Top, Pre-Formed, Nested, No Leak Style
Size: 7.625" x 5.375" x 2.5"
Case Pack: 160/case
Dim: 28.3" x 9.4" x 13.4" – Wgt: 15.21 lbs.
Cube: 2.06 – TI/HI: 06/03
UPC: 842644065584



#8 Windowed INNOBOX EDGE™ - Plain Kraft 198077472 – Stock

◆ **CUSTOM PRINT PROGRAM MIN: 25,000 pcs.**

Capacity: 29 Fluid oz.
Material: Kraft, Poly Coated Inside
Description: Tuck Top, Pre-Formed, Nested, No Leak Style
Size: 6" x 4.75" x 2.5"
Case Pack: 240/case
Dim: 24.6" x 11.8" x 15.8" – Wgt: 16.5 lbs.
Cube: 2.65 – TI/HI: 05/02
UPC: 842644065591



INNOBOX EDGE™ INSERTS



3 Compartment Taco Insert 192562291 – Stock

Capacity: 12/12/12 Fluid oz.
Material: Polypropylene
Description: PP Insert
Size: 7.75" x 5.5" x 1.81"
Case Pack: 250/case
Dim: 17.1" x 12.6" x 6.9" – Wgt: 8.8 lbs.
Cube: 0.86 – TI/HI: 06/08
UPC: 842644075064



3 Compartment Insert 192566763 – Stock

Capacity: 8/8/24 Fluid oz.
Material: Polypropylene
Description: PP Insert
Size: 7.75" x 5.5" x 1.81"
Case Pack: 250/case
Dim: 12.7" x 9.7" x 9.7" – Wgt: 7.2 lbs.
Cube: 0.69 – TI/HI: 15/04
UPC: 842644060138



2 Compartment Insert 193949023 – Stock

Capacity: 15/28 Fluid oz.
Material: Polypropylene
Description: PP Insert
Size: 7.75" x 5.5" x 1.81"
Case Pack: 250/case
Dim: 13" x 9.8" x 9.5" – Wgt: 7.4 lbs.
Cube: 0.70 – TI/HI: 15/04
UPC: 842644060145



INNOBOX EDGE™ INSERTS

- ◆ Polypropylene inserts keep food separated
- ◆ Available in our new 3 Taco Insert* or our patented 2 and 3* compartment configurations (*Patent Pending, * Patent D792,222)
- ◆ Fits perfectly into #2, #3, and #4 INNOBOX EDGE™ sizes
- ◆ Microwavable

- Hot Food Friendly
- Cold Food Friendly
- Leak Resistant

- Microwavable
- Recyclable Item*
*Check with your local municipality/store





COMMERCIALLY
COMPOSTABLE ONLY.
FACILITIES MAY NOT
EXIST IN YOUR AREA.
CERT #10528742



- ◆ NEW: Compostable Tuck Top INNOBOX EDGE™—quick and easy to open, load, and close
- ◆ BPI certified and CMA accepted compostable cartons made from SFI certified, 100% recycled kraft paperboard
- ◆ Inner PLA lining and our unique, heat sealed inset fold create strong corners, protect against leaks, and eliminate the need for glue
- ◆ Innovative closures eliminate the need to tape or rubber-band the cartons (*Patent D777,029*)
- ◆ New tear-away flaps for a better consumer experience (*Patent D876,951*)
- ◆ Cartons are nested for easy setup and come in optimized case packs for shipping, storage, and handling efficiency
- ◆ **CUSTOM PRINT PROGRAM:** Customize eligible items with your brand and design (up to 8 colors)
- ◆ Low minimum custom print runs with 12 week lead time from receipt of approved artwork

- | | | | |
|--------------------|----------------|-----------------|-----------------------|
| Hot Food Friendly | Leak Resistant | Custom Printing | Certified Compostable |
| Cold Food Friendly | Microwavable | Heat Sealed | Recyclable Item* |

* If clean and dry/Check with locally

INNOBOX EDGE™ - COMPOSTABLE KRAFT



#1 INNOBOX EDGE™ - Compostable Kraft 196151743 – Stock

♦ CUSTOM PRINT PROGRAM MIN: 30,000

Capacity: 22 Fluid oz.

Material: 100% Recycled Kraft, PLA Coated Inside

Description: Pre-Formed, Nested, Leak Resistant

Size: 4.375" x 3.562" x 2.5"

Case Pack: 180/case

Dim: 24.4" x 14" x 5.9" – Wgt: 10.2 lbs.

Cube: 1.17 – TI/Hi: 06/08

UPC: 842644071448



#2 INNOBOX EDGE™ - Compostable Kraft 191619813 – Stock

♦ CUSTOM PRINT PROGRAM MIN: 30,000

Capacity: 36 Fluid oz.

Material: 100% Recycled Kraft, PLA Coated Inside

Description: Pre-Formed, Nested, Leak Resistant

Size: 7.75" x 5.5" x 1.875"

Case Pack: 140/case

Dim: 21.7" x 9.5" x 13.6" – Wgt: 13 lbs.

Cube: 1.62 – TI/Hi: 09/03

UPC: 842644071783



#3 INNOBOX EDGE™ - Compostable Kraft 194475091 – Stock

♦ CUSTOM PRINT PROGRAM MIN: 30,000

Capacity: 56 Fluid oz.

Material: 100% Recycled Kraft, PLA Coated Inside

Description: Pre-Formed, Nested, Leak Resistant

Size: 7.75" x 5.5" x 2.5"

Case Pack: 130/case

Dim: 21.9" x 9.7" x 13.6" – Wgt: 13.6 lbs.

Cube: 1.67 – TI/Hi: 09/03

UPC: 842644071479



INNOBOX EDGE™ - COMPOSTABLE KRAFT



#4 INNOBOX EDGE™ - Compostable Kraft 194503177 – Stock

♦ CUSTOM PRINT PROGRAM MIN: 30,000

Capacity: 75 Fluid oz.

Material: 100% Recycled Kraft, PLA Coated Inside

Description: Pre-Formed, Nested, Leak Resistant

Size: 7.75" x 5.5" x 3.5"

Case Pack: 90/case

Dim: 22" x 9.5" x 13.8" – Wgt: 14 lbs.

Cube: 1.67 – TI/Hi: 09/03

UPC: 842644071455



#8 INNOBOX EDGE™ - Compostable Kraft 193408012 – Stock

♦ CUSTOM PRINT PROGRAM MIN: 30,000

Capacity: 29 Fluid oz.

Material: 100% Recycled Kraft, PLA Coated Inside

Description: Pre-Formed, Nested, Leak Resistant

Size: 6" x 4.75" x 2.5"

Case Pack: 130/case

Dim: 24.2" x 7.9" x 11.7" – Wgt: 10.25 lbs.

Cube: 1.29 – TI/Hi: 10/04

UPC: 842644071462



INNOBOX EDGE™ - TUCK TOP COMPOSTABLE KRAFT



#4 INNOBOX EDGE™ - Tuck Top Compostable Kraft 190040828 – Stock

♦ CUSTOM PRINT PROGRAM MIN: 30,000

Capacity: 75 Fluid oz.

Material: 100% Recycled Kraft, PLA Coated Inside

Description: Pre-Formed, Nested, Leak Resistant

Size: 7.75" x 5.5" x 3.5"

Case Pack: 90/case

Dim: 21.8" x 9.4" x 13.5" – Wgt: 13 lbs.

Cube: 1.6 – TI/Hi: 09/03

UPC: 842644075552



#8 INNOBOX EDGE™ - Tuck Top Compostable Kraft 191568720 – Stock

♦ CUSTOM PRINT PROGRAM MIN: 30,000

Capacity: 29 Fluid oz.

Material: 100% Recycled Kraft, PLA Coated Inside

Description: Pre-Formed, Nested, Leak Resistant

Size: 6" x 4.75" x 2.5"

Case Pack: 140/case

Dim: 24.1" x 7.5" x 11.6" – Wgt: 16.5 lbs.

Cube: 1.21 – TI/Hi: 10/04

UPC: 842644075569



CERTIFIED COMPOSTABLE.



CERTIFIED COMPOSTABLE BY BPI AND CMA ACCEPTED.

INNOBOX EDGE™ ADVANTAGE

Heat sealed, inset corners eliminate the need for glue, create strong corners, and resist leaks.

- ♦ Inset corner fold creates a streamlined edge and strong corners

- ♦ The corner is heat sealed on the inside, away from sight



PERF-ECTION: TEAR-AWAY FLAPS!*

For a better dining experience, the INNOBOX EDGE™ turns into a food tray in four easy tears.

- ♦ Specially designed perforation pattern
- ♦ All flaps easily tear away
- ♦ The INNOBOX EDGE™ becomes a food tray



* Patent D876,951



- ◆ Plain White Deli Cartons—available in fast top and barn styles—are great for packaging a variety of food, including combo meals
- ◆ Snack- and Dinner-sized, fast top cartons have a simple, easy-to-load design
- ◆ Barn carton handles provide grab-and-go convenience
- ◆ All cartons have automatic bottoms for quick, easy forming
- ◆ The vented design releases heat and steam to keep food looking fresh
- ◆ **CUSTOM PRINT PROGRAM:** Customize eligible items with your brand and design (up to 8 colors)
- ◆ Low minimum custom print runs with 12 week lead time from receipt of approved artwork

 Hot Food Friendly

 Microwavable

 Custom Printing

 Recyclable Item*
*If clean and dry

 Cold Food Friendly

PLAIN WHITE DELI CARTONS



Snack Carton

016578197 – Stock

♦ **CUSTOM PRINT PROGRAM MIN: 15,000 pcs.**

Material: SBS

Description: Fast Top, Automatic Bottom

Size: 7" x 4.25" x 2.75"

Case Pack: 500/case

Dim: 23.5" x 15.8" x 6" – Wgt: 35 lbs.

Cube: 1.29 – TI/Hi: 05/07

UPC: 842644075415



Dinner Carton

090029564 – Stock

♦ **CUSTOM PRINT PROGRAM MIN: 15,000 pcs.**

Material: SBS

Description: Fast Top, Automatic Bottom

Size: 9" x 5" x 3"

Case Pack: 400/case

Dim: 28.7" x 14.1" x 6.1" – Wgt: 39.2 lbs.

Cube: 1.43 – TI/Hi: 03/07

UPC: 842644075439



PLAIN WHITE DELI CARTONS



5 lb. Barn Carton

011382819 – Stock

♦ **CUSTOM PRINT PROGRAM MIN: 15,000 pcs.**

Material: SBS

Description: Barn Top, Automatic Bottom

Size: 8.5" x 5.5" x 3.5"

Case Pack: 150/case

Dim: 11" x 9.8" x 15" – Wgt: 24 lbs.

Cube: 0.94 – TI/Hi: 16/03

UPC: 842644075446



10 lb. Barn Carton

015936077 – Stock

♦ **CUSTOM PRINT PROGRAM MIN: 15,000 pcs.**

Material: SBS

Description: Barn Top, Automatic Bottom

Size: 9" x 6" x 6.5"

Case Pack: 150/case

Dim: 12.3" x 11" x 15.9" – Wgt: 31.4 lbs.

Cube: 1.24 – TI/Hi: 12/02

UPC: 842644075422



AUTOMATIC BOTTOMS

- ♦ Quick to form and assemble



FAST TOPS

- ♦ Easy and fast to load



BARN HANDLES

- ♦ Grab-and-go handles for convenience



DON'T FORGET SNAP SHEETS!

INNO-PAK'S SNAP SHEETS PAIR PERFECTLY WITH THESE GREAT NEW CARTONS & ARE AVAILABLE IN FIVE SIZES



- ♦ Great non-stick solution for all foods
- ♦ Grease proof, waterproof, and non-absorbent
- ♦ Interleaved pop-up sheets for easy use
- ♦ Microwavable and freezable
- ♦ Available in sizes from 6" to 15"

SNAP SHEETS ARE GREAT FOR:

- ♦ Basket liners
- ♦ Scale sheets
- ♦ Food prep wrap
- ♦ Hamburgers
- ♦ Hot dogs
- ♦ Sandwiches
- ♦ Donuts
- ♦ Muffins
- ♦ Cookies
- ♦ Bagels
- ♦ Candies
- ♦ Pretzels



- ◆ Paper food cups come in a variety of stock sizes in plain kraft, plain white SBS, and Fresh Flavor™ SBS
- ◆ Small and large vented paper and PP lids available
- ◆ NOW AVAILABLE: PET Dome Lids with and without holes now available—perfect for ice cream or snacks on the go
- ◆ Perfect for hot applications up to 190° F as well as cold and frozen applications, including ice cream* (**SBS cups with PET Dome Lids only*)
- ◆ Plain and Fresh Flavor™ SBS cups available in bulk packs as well as convenient cup/lid combo packs
- ◆ All paper food cups come sleeved and fully nested for easy setup and storage
- ◆ **CUSTOM PRINT PROGRAM:** Customize eligible items with your brand and design (up to 5 colors)
- ◆ Low minimum custom print runs with 12 week lead time from receipt of approved artwork

Hot Food Friendly

Leak Resistant

Custom Printing

Recyclable Item*

Cold Food Friendly

Microwavable

* If clean and dry
Recyclability varies by item type
Check with your local municipality/store

SOUP CUPS - PLAIN KRAFT - BULK



8 oz. Soup Cup - Plain
191719924 – Stock

♦ **CUSTOM PRINT PROGRAM MIN: 10,000 pcs.**

Material: Kraft, Poly Coated Inside

Description: Bulk Pack, Plain

Size: 8 oz.

Case Pack: 500/case

Dim: 20.1" x 8.2" x 23.1" – Wgt: 11.68 lbs.

Cube: 2.20 – TI/Hi: 12/04

UPC: 842644061524



Lids: *Small Kraft Paper - 192787274, Small PP - 198058607*
Small Dome w/Hole - 197449078, Small Dome - 192635652



10 oz. Soup Cup - Plain
192036630 – Stock

♦ **CUSTOM PRINT PROGRAM MIN: 10,000 pcs.**

Material: Kraft, Poly Coated Inside

Description: Bulk Pack, Plain

Size: 10 oz.

Case Pack: 500/case

Dim: 20.1" x 8.2" x 22" – Wgt: 12.6 lbs.

Cube: 2.10 – TI/Hi: 12/04

UPC: 842644061517



Lids: *Small Kraft Paper - 192787274, Small PP - 198058607*
Small Dome w/Hole - 197449078, Small Dome - 192635652



12 oz. Soup Cup - Plain
192771308 – Stock

♦ **CUSTOM PRINT PROGRAM MIN: 10,000 pcs.**

Material: Kraft, Poly Coated Inside

Description: Bulk Pack, Plain

Size: 12 oz.

Case Pack: 500/case

Dim: 19.5" x 8.2" x 22.5" – Wgt: 13 lbs.

Cube: 2.08 – TI/Hi: 12/04

UPC: 842644061531



Lids: *Small Kraft Paper - 192787274, Small PP - 198058607*
Small Dome w/Hole - 197449078, Small Dome - 192635652

SOUP CUPS - PLAIN KRAFT - BULK



16 oz. Tall Soup Cup - Plain
195193212 – Stock

♦ **CUSTOM PRINT PROGRAM MIN: 10,000 pcs.**

Material: Kraft, Poly Coated Inside

Description: Bulk Pack, Plain

Size: 16 oz.

Case Pack: 500/case

Dim: 20" x 8.2" x 25" – Wgt: 15.54 lbs.

Cube: 2.37 – TI/Hi: 12/03

UPC: 842644061548



Lids: *Small Kraft Paper - 192787274, Small PP - 198058607*
Small Dome w/Hole - 197449078, Small Dome - 192635652



16 oz. Squat Soup Cup - Plain
196252147 – Stock

♦ **CUSTOM PRINT PROGRAM MIN: 10,000 pcs.**

Material: Kraft, Poly Coated Inside

Description: Bulk Pack, Plain

Size: 16 oz.

Case Pack: 500/case

Dim: 23" x 9.7" x 26.6" – Wgt: 17.2 lbs.

Cube: 3.43 – TI/Hi: 08/03

UPC: 842644061555



Lids: *Large Kraft Paper - 195433050, Large PP - 191444534*



24 oz. Soup Cup - Plain
195430287 – Stock

♦ **CUSTOM PRINT PROGRAM MIN: 10,000**

Material: Kraft, Poly Coated Inside

Description: Bulk Pack, Plain

Size: 24 oz.

Case Pack: 500/case

Dim: 24.4" x 9.8" x 26" – Wgt: 22.49 lbs.

Cube: 3.6 – TI/Hi: 08/01

UPC: 842644069513



Lids: *Large Paper - 195354696, Large PP - 191444534*

SOUP CUPS - PLAIN KRAFT - BULK



32 oz. Soup Cup - Plain
198275275 – Stock

♦ **CUSTOM PRINT PROGRAM MIN: 10,000 pcs.**

Material: Kraft, Poly Coated Inside

Description: Bulk Pack, Plain

Size: 32 oz.

Case Pack: 500/case

Dim: 23.5" x 9.6" x 28" – Wgt: 24.36 lbs.

Cube: 3.66 – TI/Hi: 08/01

UPC: 842644061562



Lids: *Large Kraft Paper - 195433050, Large PP - 191444534*



6 oz. Soup Cup - Plain
199152074 – Stock

Material: SBS, Poly Coated Inside

Description: Bulk Pack, Plain

Size: 6 oz.

Case Pack: 500/case

Dim: 20" x 8.2" x 26.4" – Wgt: 10.78 lbs.

Cube: 2.51 – TI/Hi: 12/03

UPC: 842644072360



Lids: *Small Paper - 193955484, Small PP - 198058607*
Small Dome w/Hole - 197449078, Small Dome - 192635652



8 oz. Soup Cup - Plain
198453838 – Stock

♦ **CUSTOM PRINT PROGRAM MIN: 10,000 pcs.**

Material: SBS, Poly Coated Inside

Description: Bulk Pack, Plain

Size: 8 oz.

Case Pack: 500/case

Dim: 20" x 8.4" x 23.1" – Wgt: 12.6 lbs.

Cube: 2.25 – TI/Hi: 12/04

UPC: 842644029708



Lids: *Small Paper - 193955484, Small PP - 198058607*
Small Dome w/Hole - 197449078, Small Dome - 192635652

SOUP CUPS - PLAIN SBS - BULK



10 oz. Soup Cup - Plain

192731847 – Stock

♦ CUSTOM PRINT PROGRAM MIN: 10,000 pcs.

Material: SBS, Poly Coated Inside

Description: Plain, Bulk

Size: 10 oz.

Case Pack: 500/case

Dim: 19.9" x 8.4" x 21.7" – Wgt: 9.8lbs.

Cube: 2.10 – TI/Hi: 10/04

UPC: 842644034528



Lids: Small Paper - 193955484, Small PP - 198058607

Small Dome w/Hole - 197449078, Small Dome - 192635652



12 oz. Soup Cup - Plain

192847192 – Stock

♦ CUSTOM PRINT PROGRAM MIN: 10,000 pcs.

Material: SBS, Poly Coated Inside

Description: Plain, Bulk

Size: 12 oz.

Case Pack: 500/case

Dim: 20.1" x 8.2" x 22.5" – Wgt: 11.2 lbs.

Cube: 2.15 – TI/Hi: 12/04

UPC: 842644029715



Lids: Small Paper - 193955484, Small PP - 198058607

Small Dome w/Hole - 197449078, Small Dome - 192635652



16 oz. Tall Soup Cup - Plain

194204948 – Stock

♦ CUSTOM PRINT PROGRAM MIN: 10,000 pcs.

Material: SBS, Poly Coated Inside

Description: Bulk Pack, Plain

Size: 16 oz. Tall

Case Pack: 500/case

Dim: 20.1" x 8.3" x 25" – Wgt: 13.2 lbs.

Cube: 2.41 – TI/Hi: 10/03

UPC: 842644029722



Lids: Small Paper - 193955484, Small PP - 198058607

Small Dome w/Hole - 197449078, Small Dome - 192635652

SOUP CUPS - PLAIN SBS - BULK



16 oz. Squat Soup Cup - Plain

197638218 – Stock

♦ CUSTOM PRINT PROGRAM MIN: 10,000 pcs.

Material: SBS, Poly Coated Inside

Description: Bulk Pack, Plain

Size: 16 oz. Squat

Case Pack: 500/case

Dim: 23.6" x 9.7" x 26.6" – Wgt: 19.2 lbs.

Cube: 3.52 – TI/Hi: 08/03

UPC: 842644034207



Lids: Large Paper - 195354696, Large PP - 191444534



24 oz. Soup Cup - Plain

195791820 – Stock

♦ CUSTOM PRINT PROGRAM MIN: 10,000

Material: SBS, Poly Coated Inside

Description: Bulk Pack, Plain

Size: 24 oz.

Case Pack: 500/case

Dim: 24.4" x 9.8" x 26" – Wgt: 22.1 lbs.

Cube: 3.6 – TI/Hi: 08/03

UPC: 842644074401



Lids: Large Paper - 195354696, Large PP - 191444534



32 oz. Soup Cup - Plain

199878223 – Stock

♦ CUSTOM PRINT PROGRAM MIN: 10,000 pcs.

Material: SBS, Poly Coated Inside

Description: Bulk Pack, Plain

Size: 32 oz.

Case Pack: 500/case

Dim: 23.7" x 9.8" x 28.1" – Wgt: 26.00 lbs.

Cube: 3.78 – TI/Hi: 08/03

UPC: 842644029739



Lids: Large Paper - 195354696, Large PP - 191444534

A PERFECT SOLUTION FOR ICE CREAM

THESE VERSATILE PAPER CUPS ARE NOT JUST FOR SOUP!

Serve and store ice creams, sherberts, gelatos, and other frozen delights in these sturdy cups.

SBS Cups

- ♦ Freezer safe
- ♦ Available in plain white
- ♦ Sizes include 8, 10, 12, 16 Tall, 16 Squat, and 32 oz. cups

PET Dome Lids

- ♦ Crystal clear lid highlights your product
- ♦ Fits our 8, 10, 12, and 16 Tall cups
- ♦ Lids available with and without holes

White Paper Lids

- ♦ Small lids fit our 8, 10, 12, and 16 Tall oz. cups
- ♦ Large lids fit our 16 Squat, 24, and 32 oz. cups



SOUP CUPS - FRESH FLAVOR™ SBS - BULK



8 oz. Soup Cup - Fresh Flavor™
195071224 – Stock

♦ **CUSTOM PRINT PROGRAM MIN: 10,000**

Material: SBS, Poly Coated Inside

Description: Bulk Pack

Size: 8 oz.

Case Pack: 500/case

Dim.: 20" x 8.2" x 23.1" – Wgt: 12.24 lbs.

Cube: 2.19 – TI/Hi: 12/04

UPC: 842644064020



Lids: Small Paper - 193955484, Small PP - 198058607

Small Dome w/Hole - 197449078, Small Dome - 192635652



10 oz. Soup Cup - Fresh Flavor™
199155802 – Stock

♦ **CUSTOM PRINT PROGRAM MIN: 10,000**

Material: SBS, Poly Coated Inside

Description: Bulk Pack

Size: 10 oz.

Case Pack: 500/case

Dim.: 20" x 8.1" x 21.7" – Wgt: 13.34 lbs.

Cube: 2.03 – TI/Hi: 12/04

UPC: 842644063849



Lids: Small Paper - 193955484, Small PP - 198058607

Small Dome w/Hole - 197449078, Small Dome - 192635652



12 oz. Soup Cup - Fresh Flavor™
196256252 – Stock

♦ **CUSTOM PRINT PROGRAM MIN: 10,000**

Material: SBS, Poly Coated Inside

Description: Bulk Pack

Size: 12 oz.

Case Pack: 500/case

Dim.: 20" x 8.2" x 22.5" – Wgt: 10.8 lbs.

Cube: 2.14 – TI/Hi: 12/04

UPC: 842644063771



Lids: Small Paper - 193955484, Small PP - 198058607

Small Dome w/Hole - 197449078, Small Dome - 192635652

SOUP CUPS - FRESH FLAVOR™ SBS - BULK



16 oz. Tall Soup Cup - Fresh Flavor™
193759666 – Stock

♦ **CUSTOM PRINT PROGRAM MIN: 10,000**

Material: SBS, Poly Coated Inside

Description: Bulk Pack

Size: 16 oz. Tall

Case Pack: 500/case

Dim.: 20" x 8.2" x 25" – Wgt: 12.6 lbs.

Cube: 2.37 – TI/Hi: 12/03

UPC: 842644063825



Lids: Small Paper - 193955484, Small PP - 198058607

Small Dome w/Hole - 197449078, Small Dome - 192635652



16 oz. Squat Soup Cup - Fresh Flavor™
193848164 – Stock

♦ **CUSTOM PRINT PROGRAM MIN: 10,000**

Material: SBS, Poly Coated Inside

Description: Bulk Pack

Size: 16 oz. Squat

Case Pack: 500/case

Dim.: 23.6" x 10" x 26.8" – Wgt: 19.8 lbs.

Cube: 3.66 – TI/Hi: 08/03

UPC: 842644064051



Lids: Large Paper - 195354696, Large PP - 191444534



32 oz. Soup Cup - Fresh Flavor™
194581169 – Stock

♦ **CUSTOM PRINT PROGRAM MIN: 10,000**

Material: SBS, Poly Coated Inside

Description: Bulk Pack

Size: 32 oz.

Pack: 500/case

Dim.: 23.5" x 9.7" x 27.8" – Wgt: 25.22 lbs.

Cube: 3.67 – TI/Hi: 08/03

UPC: 842644063948



Lids: Large Paper - 195354696, Large PP - 191444534

SOUP CUPS - WITH BARCODES - BULK



8 oz. Soup Cup w/Barcode
197587072 – Stock

♦ **CUSTOM PRINT PROGRAM MIN: 10,000**

Material: SBS, Poly Coated Inside

Description: Bulk Pack

Size: 8 oz.

Case Pack: 500/case

Dim.: 20" x 8.2" x 23.1" – Wgt: 12.79 lbs.

Cube: 2.19 – TI/Hi: 12/04

UPC: 842644053970



Lids: Small Paper - 193955484, Small PP - 198058607

Small Dome w/Hole - 197449078, Small Dome - 192635652



16 oz. Squat Soup Cup w/Barcode
192582564 – Stock

♦ **CUSTOM PRINT PROGRAM MIN: 10,000**

Material: SBS, Poly Coated Inside

Description: Bulk Pack

Size: 16 oz. Squat

Case Pack: 500/case

Dim.: 23.5" x 9.7" x 26.6" – Wgt: 19 lbs.

Cube: 3.51 – TI/Hi: 08/03

UPC: 842644058364



Lids: Large Paper - 195354696, Large PP - 191444534



24 oz. Soup Cup w/Barcode
191260486 – Stock

♦ **CUSTOM PRINT PROGRAM MIN: 10,000**

Material: SBS, Poly Coated Inside

Description: Bulk Pack

Size: 24 oz.

Case Pack: 500/case

Dim.: 24" x 9.8" x 26.6" – Wgt: 21.6 lbs.

Cube: 3.62 – TI/Hi: 08/01

UPC: 842644058357



Lids: Large Paper - 195354696, Large PP - 191444534

SAVE SPACE WITH COMBO PACKS

COMBOS PACKS INCLUDE CUPS & PAPER AND PP LIDS:

- ◆ White SBS cups with white SBS lids
- ◆ White SBS cups with clear PP lids
- ◆ Fresh Flavor™ SBS cups with white SBS lids
- ◆ Fresh Flavor™ SBS cups with clear PP lids
- ◆ Packed in sets of 250 Cup and Lids
- ◆ Cuts storage space used to house product
- ◆ Cups available with white SBS lids or clear PP lids



SOUP CUPS - PLAIN SBS - COMBO



8 oz. Soup Cup w/White Paper Lid - Plain 191435486 – Stock

◆ **CUSTOM PRINT PROGRAM MIN: 10,000 pcs.**

Material: SBS, Poly Coated Inside

Description: Combo Pack, Plain

Size: 8 oz.

Case Pack: 250 sets/case

Dim: 20.5" x 8.5" x 28.2" – Wgt: 12.79 lbs.

Cube: 2.84 – TI/Hi: 10/03

UPC: 842644034535



SOUP CUPS - PLAIN SBS - COMBO



10 oz. Soup Cup w/White Paper Lid - Plain 193342088 – Stock

◆ **CUSTOM PRINT PROGRAM MIN: 10,000 pcs.**

Material: SBS, Poly Coated Inside

Description: Combo Pack, Plain

Size: 10 oz.

Case Pack: 250 sets/case

Dim: 20.5" x 8.7" x 28.2" – Wgt: 11.4 lbs.

Cube: 2.91 – TI/Hi: 10/03

UPC: 842644030261



12 oz. Soup Cup w/White Paper Lid - Plain 191676895 – Stock

◆ **CUSTOM PRINT PROGRAM MIN: 10,000 pcs.**

Material: SBS, Poly Coated Inside

Description: Combo Pack, Plain

Size: 12 oz.

Case Pack: 250 sets/case

Dim: 20.5" x 8.5" x 28.5" – Wgt: 12.2 lbs.

Cube: 2.87 – TI/Hi: 10/03

UPC: 842644030278



16 oz. Soup Cup w/White Paper Lid - Plain 190392053 – Stock

◆ **CUSTOM PRINT PROGRAM MIN: 10,000 pcs.**

Material: SBS, Poly Coated Inside

Description: Combo Pack, Plain

Size: 16 oz. Tall

Case Pack: 250 sets/case

Dim: 20.5" x 8.5" x 28.7" – Wgt: 12.8 lbs.

Cube: 2.89 – TI/Hi: 10/03

UPC: 842644030285



SOUP CUPS - PLAIN SBS - COMBO



16 oz. Squat Soup Cup w/White Paper Lid - Plain 193184242 – Stock

◆ **CUSTOM PRINT PROGRAM MIN: 10,000 pcs.**

Material: SBS, Poly Coated Inside

Description: Combo Pack, Plain

Size: 16 oz. Squat

Case Pack: 250 sets/case

Dim: 24.5" x 9.8" x 30.7" – Wgt: 17 lbs.

Cube: 4.27 – TI/Hi: 08/03

UPC: 842644034559



32 oz. Soup Cup w/White Paper Lid - Plain 192269453 – Stock

◆ **CUSTOM PRINT PROGRAM MIN: 10,000 pcs.**

Material: SBS, Poly Coated Inside

Description: Combo Pack, Plain

Size: 32 oz.

Case Pack: 250 sets/case

Dim: 24.5" x 9.8" x 32.3" – Wgt: 21 lbs.

Cube: 4.49 – TI/Hi: 08/03

UPC: 842644030292



8 oz. Soup Cup w/PP Lid - Plain 193503866 – Stock

◆ **CUSTOM PRINT PROGRAM MIN: 10,000 pcs.**

Material: SBS, Poly Coated Inside, PP

Description: Combo Pack, Plain

Size: 8 oz.

Case Pack: 184 sets/case

Dim: 20.2" x 8.4" x 5.1" – Wgt: 7 lbs.

Cube: 0.50 – TI/Hi: 10/06

UPC: 842644027681



*Lid only

SOUP CUPS - PLAIN SBS - COMBO



16 oz. Squat Soup Cup w/PP Lid - Plain
192041966 – Stock

♦ **CUSTOM PRINT PROGRAM MIN: 10,000 pcs.**

Material: SBS, Poly Coated Inside, PP

Description: Combo Pack, Plain

Size: 16 oz. Squat

Case Pack: 216 sets/case

Dim.: 19.1" x 9.7" x 23.3" – Wgt: 12 lbs.

Cube: 2.50 – TI/Hi: 10/02

UPC: 842644027711



*Lid only

SOUP CUPS - FRESH FLAVOR™ SBS - COMBO



10 oz. Soup Cup w/Paper Lid - Fresh Flavor™
195127982 – Stock

♦ **CUSTOM PRINT PROGRAM MIN: 10,000**

Material: SBS, Poly Coated Inside

Description: Combo Pack

Size: 10 oz.

Case Pack: 250/case

Dim.: 20.5" x 8.6" x 28.2" – Wgt: 11.8lbs.

Cube: 2.88 – TI/Hi: 10/03

UPC: 842644063856



12 oz. Soup Cup w/Paper Lid - Fresh Flavor™
199847604 – Stock

♦ **CUSTOM PRINT PROGRAM MIN: 10,000**

Material: SBS, Poly Coated Inside

Description: Combo Pack

Size: 12 oz.

Case Pack: 250 sets/case

Dim.: 20.5" x 8.6" x 28.2" – Wgt: 12 lbs.

Cube: 2.88 – TI/Hi: 10/03

UPC: 842644063788



SOUP CUPS - FRESH FLAVOR™ SBS - COMBO



16 oz. Soup Cup w/Paper Lid - Fresh Flavor™
195527680 – Stock

♦ **CUSTOM PRINT PROGRAM MIN: 10,000**

Material: SBS, Poly Coated Inside

Description: Combo Pack

Size: 16 oz. Tall

Case Pack: 250 sets/case

Dim.: 20.5" x 8.5" x 28.7" – Wgt: 12.8 lbs.

Cube: 2.89 – TI/Hi: 10/03

UPC: 842644063801



32 oz. Soup Cup w/Paper Lid - Fresh Flavor™
198209164 – Stock

♦ **CUSTOM PRINT PROGRAM MIN: 10,000 pcs.**

Material: SBS, Poly Coated Inside

Description: Combo Pack

Size: 32 oz.

Case Pack: 250 sets/case

Dim.: 24.4" x 9.8" x 32.3" – Wgt: 20.83 lbs.

Cube: 4.47 – TI/Hi: 08/03

UPC: 842644065072



10oz. Soup Cup w/PP Lid - Fresh Flavor™
199930612 – Stock

♦ **CUSTOM PRINT PROGRAM MIN: 10,000 pcs.**

Material: SBS, Poly Coated Inside, PP

Description: Combo Pack

Size: 10 oz.

Case Pack: 250 sets/case

Dim.: 20" x 8.1" x 20.5" – Wgt: 7.94 lbs.

Cube: 1.92 – TI/Hi: 12/04

UPC: 842644063863



*Lid only

SOUP CUPS - FRESH FLAVOR™ SBS - COMBO



12 oz. Soup Cup w/PP Lid - Fresh Flavor™
192946783 – Stock

♦ **CUSTOM PRINT PROGRAM MIN: 10,000 pcs.**

Material: SBS, Poly Coated Inside, PP

Description: Combo Pack

Size: 12 oz.

Case Pack: 250 sets/case

Dim.: 20" x 8.2" x 20.5" – Wgt: 8.6 lbs.

Cube: 1.95 – TI/Hi: 12/04

UPC: 842644063795



*Lid only



16 oz. Squat Soup Cup w/PP Lid - Fresh Flavor™
194495736 – Stock

♦ **CUSTOM PRINT PROGRAM MIN: 10,000 pcs.**

Material: SBS, Poly Coated Inside, PP

Description: Combo Pack

Size: 16 oz. Squat

Case Pack: 250 sets/case

Dim.: 24.5" x 9.8" x 23" – Wgt: 14 lbs.

Cube: 3.20 – TI/Hi: 08/04

UPC: 842644063818



*Lid only



32 oz. Soup Cup w/PP Lid - Fresh Flavor™
196534034 – Stock

♦ **CUSTOM PRINT PROGRAM MIN: 10,000 pcs.**

Material: SBS, Poly Coated Inside, PP

Description: Combo Pack

Size: 32 oz.

Case Pack: 250 sets/case

Dim.: 24.4" x 9.8" x 24.4" – Wgt: 15.43 lbs.

Cube: 3.38 – TI/Hi: 08/04

UPC: 842644064044



*Lid only

PAPER LIDS - KRAFT



Small Kraft Paper Lid 192787274 – Stock

Material: Kraft, Poly Coated Inside
Description: Bulk Pack
Size: 6/8, 8/10, 12, 16T oz.
Case Pack: 500/case
Dim: 20.5" x 8.6" x 30.5" – Wgt: 13.56 lbs.
Cube: 3.11 – TI/Hi: 10/03
UPC: 842644061579



Large Kraft Paper Lid 195433050 – Stock

Material: Kraft, Poly Coated Inside
Description: Bulk Pack
Size: 16S, 24, 32 oz.
Case Pack: 500/case
Dim: 24.5" x 9.8" x 30.3" – Wgt: 15 lbs.
Cube: 4.21 – TI/Hi: 08/03
UPC: 842644061586



PAPER LIDS - SBS



Small White Paper Lid 193955484 – Stock

Material: SBS, Poly Coated Inside
Description: Bulk Pack
Size: 6/8, 8/10, 12, 16T oz.
Case Pack: 500/case
Dim: 20.5" x 8.8" x 30.5" – Wgt: 12.4 lbs.
Cube: 3.18 – TI/Hi: 10/03
UPC: 842644034566



PAPER LIDS - SBS



Large White Paper Lid 195354696 – Stock

Material: SBS, Poly Coated Inside
Description: Bulk Pack
Size: 16S, 24, 32 oz.
Case Pack: 500/case
Dim: 24.4" x 10" x 30" – Wgt: 15.4 lbs.
Cube: 4.24 – TI/Hi: 08/03
UPC: 842644034573



PP LIDS



Small PP Lid Bulk 198058607 – Stock

Material: PP
Description: Bulk Pack
Size: 6/8, 8/10, 12, 16T oz.
Case Pack: 500/case
Dim: 20.5" x 8.7" x 15.5" – Wgt: 6.2 lbs.
Cube: 1.60 – TI/Hi: 10/03
UPC: 842644034580



Large PP Lid Bulk 191444534 – Stock

Material: PP
Description: Bulk Pack
Size: 16S, 24, 32 oz.
Case Pack: 500/case
Dim: 24.2" x 10" x 15.1" – Wgt: 7.6 lbs.
Cube: 2.14 – TI/Hi: 08/03
UPC: 842644034597



PET DOME LIDS



PET Dome Lid w/Hole 197449078 – Stock

Material: PET
Description: Bulk Pack
Size: 6/8, 8/10, 12, 16T oz.
Case Pack: 500/case
Dim: 20.7" x 15.9" x 8.9", 1.75" hole – Wgt: 6.2 lbs.
Cube: 1.70 – TI/Hi: 5/11
UPC: 842644075262





PET Dome Lid without Hole 192635652 – Stock



Material: PET
Description: Bulk Pack
Size: 6/8, 8/10, 12, 16T oz.
Case Pack: 500/case
Dim: 20.7" x 15.9" x 8.9" – Wgt: 7.7 lbs.
Cube: 1.70 – TI/Hi: 5/11
UPC: 842644075279





- ◆ Bulk pack printed and plain SBS and Kraft Buckets available in a variety of sizes
- ◆ Great for hot or cold applications including use as ice buckets
- ◆ Suitable for warming units and hot applications up to 190° F
- ◆ Choose from a variety of lid options including a vented anti-fog PP dome lid, flat non-vented anti-fog PP lid, and paper lids
- ◆ Fully nested for easy setup and storage
- ◆ **CUSTOM PRINT PROGRAM:** Customize eligible items with your brand and design (up to 5 colors)
- ◆ Low minimum custom print runs with 12 week lead time from receipt of approved artwork

 Hot Food Friendly
 Cold Food Friendly

 Leak Resistant
 Microwavable

 Custom Printing

 Recyclable Item*
* If clean and dry
Recyclability varies by item type
Check with your local municipality/store

KRAFT BUCKETS - BULK



54 oz. Short Bucket - Plain
195074180 – Stock

♦ **CUSTOM PRINT PROGRAM MIN: 10,000 pcs.**

Material: Kraft, Poly Coated Inside

Description: Bulk Pack, Plain

Size: 54 oz.

Case Pack: 165/case

Dim.: 23.1" x 7.8" x 23" – Wgt: 10.80 lbs.

Cube: 2.40 – TI/Hi: 10/04

UPC: 842644062378



Lids: Paper - 196069468, Dome PP - 191168207,
Flat PP - 193208817



54 oz. Short Bucket - Fresh Flavor™
195074181 – Stock

♦ **CUSTOM PRINT PROGRAM MIN: 10,000 pcs.**

Material: Kraft, Poly Coated Inside

Description: Bulk Pack, Plain

Size: 54 oz.

Case Pack: 165/case

Dim.: 23" x 7.7" x 22.8" – Wgt: 13.19 lbs.

Cube: 2.34 – TI/Hi: 10/04

UPC: 842644064372



Lids: Paper - 196069468, Dome PP - 191168207,
Flat PP - 193208817

SBS BUCKETS - BULK



38 oz. Short Bucket - Plain
190721723 – Stock

♦ **CUSTOM PRINT PROGRAM MIN: 10,000 pcs.**

Material: SBS, Poly Coated Inside

Description: Bulk Pack, Plain

Size: 38 oz.

Case Pack: 234/case

Dim.: 23" x 15.2" x 22.8" – Wgt: 16.98 lbs.

Cube: 4.61 – TI/Hi: 05/04

UPC: 842644061227



SBS BUCKETS - BULK



54 oz. Short Bucket - Plain
193846447 – Stock

♦ **CUSTOM PRINT PROGRAM MIN: 10,000 pcs.**

Material: SBS, Poly Coated Inside

Description: Bulk Pack, Plain

Size: 54 oz.

Case Pack: 165/case

Dim.: 23" x 8" x 23" – Wgt: 12.04 lbs.

Cube: 2.45 – TI/Hi: 10/04

UPC: 842644073053



Lids: Paper - 196069468, Dome PP - 191168207,
Flat PP - 193208817



54 oz. Short Bucket - Fresh Flavor™
193926641 – Stock

♦ **CUSTOM PRINT PROGRAM MIN: 10,000 pcs.**

Material: SBS, Poly Coated Inside

Description: Bulk Pack

Size: 54 oz.

Case Pack: 165/case

Dim.: 23" x 8" x 23" – Wgt: 12.19 lbs.

Cube: 2.45 – TI/Hi: 10/04

UPC: 842644064037



Lids: Paper - 196069468, Dome PP - 191168207,
Flat PP - 193208817



85 oz. Bucket - Plain
199634074 – Stock

♦ **CUSTOM PRINT PROGRAM MIN: 10,000 pcs.**

Material: SBS, Poly Coated Inside

Description: Bulk Pack, with Ridge

Size: 85 oz.

Case Pack: 200/case

Dim.: 15.4" x 15.4" x 23.8" – Wgt: 19.40 lbs.

Cube: 3.27 – TI/Hi: 06/04

UPC: 842644066284



Lids: Paper - 196069468, Dome PP - 191168207,
Flat PP - 193208817

SBS BUCKETS - BULK



85 oz. Bucket - Fresh Flavor™
198389703 – Stock

♦ **CUSTOM PRINT PROGRAM MIN: 10,000 pcs.**

Material: SBS, Poly Coated Inside

Description: Bulk Pack, with Ridge

Size: 85 oz.

Case Pack: 200/case

Dim.: 15.5" x 15.3" x 23.8" – Wgt: 18.20 lbs.

Cube: 3.27 – TI/Hi: 06/01

UPC: 842644064013



Lids: Paper - 196069468, Dome PP - 191168207,
Flat PP - 193208817



130 oz. Bucket - Fresh Flavor™
196496866 – Stock

♦ **CUSTOM PRINT PROGRAM MIN: 10,000 pcs.**

Material: SBS, Poly Coated Inside

Description: Bulk Pack, with Ridge

Size: 130 oz.

Case Pack: 200/case

Dim.: 17.3" x 17.3" x 28.7" – Wgt: 26.26 lbs.

Cube: 4.97 – TI/Hi: 04/01

UPC: 842644063924



Lids: 130 oz. Paper - 192708717



170 oz. Bucket - Fresh Flavor™
198562751 – Stock

♦ **CUSTOM PRINT PROGRAM MIN: 10,000 pcs.**

Material: SBS, Poly Coated Inside

Description: Bulk Pack, with Ridge

Size: 170 oz.

Case Pack: 100/case

Dim.: 18.1" x 18.1" x 18.9" – Wgt: 17.05 lbs.

Cube: 3.58 – TI/Hi: 04/05

UPC: 842644063931



Lids: 170 oz. Paper - 193428926

BUCKET LIDS - BULK



54/85 oz. Bucket Paper Lid

196069468 – Stock

Material: SBS, Poly Coat

Description: Bulk Pack, White, Inset Lid w/Coating
Size: 54/85 oz.

Case Pack: 200/case

Dim.: 7.6" x 7.8" x 7.7" – Wgt: 7.61 lbs.

Cube: 0.26 – TI/Hi: 30/06

UPC: 842644039455



130 oz. Bucket Paper Lid

192708717 – Stock

Material: SBS, Poly Coat

Description: Bulk Pack, White, Inset Lid w/Coating
Size: 130 oz.

Case Pack: 200/case

Dim.: 8.7" x 8.6" x 7.7" – Wgt: 9.6 lbs.

Cube: 0.33 – TI/Hi: 16/12

UPC: 842644039448



170 oz. Bucket Paper Lid

193428926 – Stock

Material: SBS, Poly Coat

Description: Bulk Pack, White, Inset Lid w/Coating
Size: 170 oz.

Case Pack: 200/case

Dim.: 9.3" x 9.3" x 7.5" – Wgt: 10.58 lbs.

Cube: 0.38 – TI/Hi: 20/06

UPC: 842644041267



BUCKET LIDS - BULK



42/44/54/85 oz. PP Bucket Lid

191168207 – Stock

Material: PP

Description: Bulk Pack, Anti Fog, Vented
Fits Size: 42, 44, 54, 85 oz.

Case Pack: 360/case

Dim.: 23.2" x 15.7" x 16.1" – Wgt: 16.6 lbs.

Cube: 3.39 – TI/Hi: 05/06

UPC: 842644030520



42/44/54/85 oz. Flat PP Bucket Lid

193208817 – Stock

Material: PP

Description: Bulk Pack, Anti Fog, Non-Vented
Fits Size: 42, 44, 54, 85 oz.

Case Pack: 360/case

Dim.: 24.5" x 16.8" x 15.1" – Wgt: 14.33 lbs.

Cube: 3.6 – TI/Hi: 04/03

UPC: 842644071189



MERCHANDISE MULTIPLE ITEMS IN YOUR BUCKETS

3-WAY BUCKET DIVIDERS

Serve multiple items with ease using Inno-Pak's Bucket Dividers.

These 3-Way dividers are made from durable SBS and come in three different sizes to fit the 85 oz., 130 oz., and 170 oz. buckets.

85 oz. Bucket Divider

261311183 – Make & Ship

130 oz. Bucket Divider

012660047 – Make & Ship

170 oz. Bucket Divider

014474227 – Make & Ship





- ◆ Clamshell style containers available in popular sizes and in single and three cell configurations
- ◆ Clear, breakaway lids with black bases
- ◆ Vented lids allow for hot or cold applications *(Keep vents closed for cold applications and open for hot)*
- ◆ Heat lamp, warming unit, and microwave safe
- ◆ All containers are stackable
- ◆ Durable and reusable

Hot Food Friendly

Leak Resistant

Microwavable

Recyclable Item*

Cold Food Friendly

Reusable Item

* If clean and dry
Check with your local municipality/store

RIGID CLAMSHELL CONTAINERS



Rigid 1 Cell Dinner Box Container

343523183 – Stock

Capacity: 48 Fluid oz.

Material: PP Clear Top, Black Bottom

Description: 1 Cell, Clamshell, Breakaway Hinge

Size: 11" x 8.5" x 3.15"

Case Pack: 116/case

Dim: 23.6" x 15.7" x 18.2" – Wgt: 21 lbs.

Cube: 3.90 – TI/HI: 05/05

UPC: 842644067403



Rigid 2 Cell Dinner Box Container

346054110 – Stock

Capacity: 24/16 Fluid oz.

Material: PP Clear Top, Black Bottom

Description: 2 Cell, Clamshell, Breakaway Hinge

Size: 11" x 8.5" x 3.15"

Case Pack: 116/case

Dim: 23.6" x 15.7" x 18.2" – Wgt: 21 lbs.

Cube: 3.90 – TI/HI: 05/05

UPC: 842644068981



RIGID CLAMSHELL CONTAINERS



Rigid 3 Cell Dinner Box Container

347868976 – Stock

Capacity: 28/8/8 Fluid oz.

Material: PP Clear Top, Black Bottom

Description: 3 Cell, Clamshell, Breakaway Hinge

Size: 11" x 8.5" x 3.15"

Case Pack: 116/case

Dim: 23.6" x 15.8" x 18.2" – Wgt: 21 lbs.

Cube: 3.93 – TI/HI: 05/05

UPC: 842644068998



6" Rigid 1 Cell Carry Out Container

292187268 – Stock

Capacity: 22 Fluid oz.

Material: PP Clear Top, Black Bottom

Description: 1 Cell, Clamshell, Breakaway Hinge

Size: 6" x 6" x 3.18"

Case Pack: 171/case

Dim: 19.7" x 15.8" x 13.4" – Wgt: 10.95 lbs.

Cube: 2.41 – TI/HI: 06/07

UPC: 842644035242



RIGID CLAMSHELL CONTAINERS



8" Rigid 1 Cell Carry Out Container

299361678 – Stock

Capacity: 39 Fluid oz.

Material: PP Clear Top, Black Bottom

Description: 1 Cell, Clamshell, Breakaway Hinge

Size: 8" x 8" x 2.71"

Case Pack: 138/case

Dim: 19.7" x 16.5" x 16.9" – Wgt: 14.6 lbs.

Cube: 3.18 – TI/HI: 06/05

UPC: 842644035204



8" Rigid 3 Cell Carry Out Container

340116174 – Stock

Capacity: 15/6/6 Fluid oz.

Material: PP Clear Top, Black Bottom

Description: 3 Cell, Clamshell, Breakaway Hinge

Size: 8" x 8" x 2.71"

Case Pack: 138/case

Dim: 19.7" x 16.5" x 16.9" – Wgt: 14.6 lbs.

Cube: 3.18 – TI/HI: 06/05

UPC: 842644067397





RIGID 2-PIECE CONTAINERS



- ◆ Durable, injection molded, 2-piece microwavable containers with black bases & clear lids
- ◆ Available in 14 sizes and configurations, including round, rectangle, and 3-compartment
- ◆ Clear, PP deli containers with clear lids are available in five sizes from 8 to 32 ounces
- ◆ Perfect for dinner combos, salads, pastas, soups, sides, and more
- ◆ Great for packaging delivery, takeout, and leftover food for customers
- ◆ Containers and soup cups are not only microwave safe, they're dishwasher safe, too
- ◆ All containers are recyclable and reusable
- ◆ [Ask for more information on these great products at innopak.com/contact](https://www.innopak.com/contact)

- Hot Food Friendly
- Cold Food Friendly
- Microwavable
- Leak Resistant
- Recyclable Item*

*Check with your local municipality/store

RIGID 2-PIECE CONTAINERS



12 oz. Rectangular Container 298852482 – Stock

Capacity: 12 Fluid oz.

Material: PP

Description: PP, Black Bottom, Clear Top, 2-Piece

Size: 5.9" x 4.6" x 1.4"

Case Pack: 150/case

Dim: 13.7" x 6.1" x 12.8" – Wgt: 7.28 lbs.

Cube: 0.62 – TI/Hi: 22/03

UPC: 842644077563



RIGID 2-PIECE CONTAINERS



16 oz. Rectangular Container

296356334 – Stock

Capacity: 16 Fluid oz.

Material: PP

Description: PP, Black Bottom, Clear Top, 2-Piece

Size: 7.9" x 5.4" x 1.4"

Case Pack: 150/case

Dim: 16.5" x 8.1" x 13.2" – Wgt: 11.46 lbs.

Cube: 1.02 – TI/Hi: 13/03

UPC: 842644077570



24 oz. Rectangular Container

293092191 – Stock

Capacity: 24 Fluid oz.

Material: PP

Description: PP, Black Bottom, Clear Top, 2-Piece

Size: 7.9" x 5.4" x 1.97"

Case Pack: 150/case

Dim: 16.5" x 8.1" x 13.6" – Wgt: 12.13 lbs.

Cube: 1.05 – TI/Hi: 13/03

UPC: 842644077587



28 oz. Rectangular Container

293630590 – Stock

Capacity: 28 Fluid oz.

Material: PP

Description: PP, Black Bottom, Clear Top, 2-Piece

Size: 8.7" x 5.9" x 1.5"

Case Pack: 150/case

Dim: 18.3" x 8.9" x 12.8" – Wgt: 16.45 lbs.

Cube: 1.21 – TI/Hi: 10/03

UPC: 842644077594



RIGID 2-PIECE CONTAINERS



32 oz. Rectangular Container

290333908 – Stock

Capacity: 32 Fluid oz.

Material: PP

Description: PP, Black Bottom, Clear Top, 2-Piece

Size: 8.8" x 5.9" x 1.8"

Case Pack: 150/case

Dim: 18.5" x 8.8" x 12.5" – Wgt: 16.5 lbs.

Cube: 1.18 – TI/Hi: 10/03

UPC: 842644077600



32 oz. Rectangular Container 2-Compartment

290745352 – Stock

Capacity: 12/20 Fluid oz.

Material: PP

Description: PP, Black Bottom, Clear Top, 2-Piece

Size: 8.8" x 6" x 1.9"

Case Pack: 150/case

Dim: 18.3" x 9.1" x 15.4" – Wgt: 17.75 lbs.

Cube: 1.48 – TI/Hi: 10/03

UPC: 842644077631



32 oz. Rectangular Container 3-Compartment

297392153 – Stock

Capacity: 16/8/8 Fluid oz.

Material: PP

Description: PP, Black Bottom, Clear Top, 2-Piece

Size: 8.8" x 6" x 1.9"

Case Pack: 150/case

Dim: 23" x 10" x 16.7" – Wgt: 23.1 lbs.

Cube: 2.22 – TI/Hi: 08/02

UPC: 842644077655



RIGID 2-PIECE CONTAINERS



38 oz. Rectangular Container

296741221 – Stock

Capacity: 38 Fluid oz.

Material: PP

Description: PP, Black Bottom, Clear Top, 2-Piece

Size: 8.7" x 5.9" x 2"

Case Pack: 150/case

Dim: 18.5" x 8.9" x 14.2" – Wgt: 17.7 lbs.

Cube: 1.35 – TI/Hi: 10/03

UPC: 842644077617



58 oz. Rectangular Container

292571176 – Stock

Capacity: 58 Fluid oz.

Material: PP

Description: PP, Black Bottom, Clear Top, 2-Piece

Size: 11.5" x 7.8" x 1.7"

Case Pack: 150/case

Dim: 24.4" x 11.9" x 15" – Wgt: 25.2 lbs.

Cube: 2.52 – TI/Hi: 06/03

UPC: 842644077624



16 oz. Round Container

296052083 – Stock

Capacity: 16 Fluid oz.

Material: PP

Description: PP, Black Bottom, Clear Top, 2-Piece

Size: 6.2" x 1.6"

Case Pack: 150/case

Dim: 19" x 6.5" x 13" – Wgt: 9.70 lbs.

Cube: 0.93 – TI/Hi: 14/03

UPC: 842644077525



RIGID 2-PIECE CONTAINERS



24 oz. Round Container

295157763 – Stock

Capacity: 24 Fluid oz.

Material: PP

Description: PP, Black Bottom, Clear Top, 2-Piece

Size: 7.2" x 1.6"

Case Pack: 150/case

Dim: 22.1" x 7.5" x 13.9" – Wgt: 13.23 lbs.

Cube: 1.33 – TI/Hi: 10/03

UPC: 842644077532



32 oz. Round Container

290874845 – Stock

Capacity: 32 Fluid oz.

Material: PP

Description: PP, Black Bottom, Clear Top, 2-Piece

Size: 7.2" x 1.97"

Case Pack: 150/case

Dim: 22.2" x 7.5" x 14.5" – Wgt: 14 lbs.

Cube: 1.4 – TI/Hi: 10/03

UPC: 842644077549



33 oz. Round Container 3-Compartments

295598624 – Stock

Capacity: 14/11.5/7.5 Fluid oz.

Material: PP

Description: PP, Black Bottom, Clear Top, 2-Piece

Size: 9" x 1.6"

Case Pack: 150/case

Dim: 27" x 9.2" x 15.2" – Wgt: 22.09 lbs.

Cube: 2.19 – TI/Hi: 05/03

UPC: 842644077648



RIGID 2-PIECE CONTAINERS



48 oz. Round Container

292624866 – Stock

Capacity: 48 Fluid oz.

Material: PP

Description: PP, Black Bottom, Clear Top, 2-Piece

Size: 9.3" x 1.9"

Case Pack: 150/case

Dim: 28.4" x 9.7" x 15" – Wgt: 23.5 lbs.

Cube: 2.39 – TI/Hi: 05/03

UPC: 842644077556



8 oz. PP Deli Containers w/ LDPE Lid

299950355 – Stock

Capacity: 8 Fluid oz.

Material: PP, LDPE

Description: PP, Clear Bottom, LDPE, Clear Top

Size: 4.6" x 1.7"

Case Pack: 240/case

Dim: 23.4" x 9.5" x 11.5" – Wgt: 14.73 lbs.

Cube: 1.48 – TI/Hi: 08/04

UPC: 842644077662



12 oz. PP Deli Containers w/ LDPE Lid

291373899 – Stock

Capacity: 12 Fluid oz.

Material: PP, LDPE

Description: PP, Clear Bottom, LDPE, Clear Top

Size: 2.37" x 1.5"

Case Pack: 240/case

Dim: 23.4" x 9.5" x 11.8" – Wgt: 15.13 lbs.

Cube: 1.52 – TI/Hi: 08/03

UPC: 842644077679



RIGID 2-PIECE CONTAINERS



16 oz. PP Deli Containers w/ LDPE Lid

293440843 – Stock

Capacity: 16 Fluid oz.

Material: PP, LDPE

Description: PP, Clear Bottom, LDPE, Clear Top

Size: 3.1" x 1.7"

Case Pack: 240/case

Dim: 23.4" x 9.5" x 12.9" – Wgt: 16.48 lbs.

Cube: 1.66 – TI/Hi: 08/03

UPC: 842644077686



24 oz. PP Deli Containers w/ LDPE Lid

296422310 – Stock

Capacity: 24 Fluid oz.

Material: PP, LDPE

Description: PP, Clear Bottom, LDPE, Clear Top

Size: 4.5" x 1.7"

Case Pack: 240/case

Dim: 23.4" x 9.5" x 15.2" – Wgt: 16.4 lbs.

Cube: 1.96 – TI/Hi: 07/03

UPC: 842644077693



32 oz. PP Deli Containers w/ LDPE Lid

290940323 – Stock

Capacity: 32 Fluid oz.

Material: PP, LDPE

Description: PP, Clear Bottom, LDPE, Clear Top

Size: 5.5" x 1.7"

Case Pack: 240/case

Dim: 23.4" x 9.5" x 20.8" – Wgt: 21.27 lbs.

Cube: 2.68 – TI/Hi: 08/02

UPC: 842644077709





- ◆ Containers are available in white or natural brown (*unbleached*) and made from annually renewable materials
- ◆ Made from compostable bagasse
- ◆ Designed to securely stack multiple containers
- ◆ Fully nested for easy setup and storage
- ◆ Grease and cut resistant
- ◆ **CUSTOM PRINT PROGRAM:** Customize with your brand and design (up to 2 colors) or choose to emboss

- ◆ Stock crystal clear PET dome and flat lids provide exceptional food presentation and are available in multiple heights and sizes
- ◆ Custom lids available in PET, rPET (*made from recycled plastic*), PP, and PLA (*PLA is made from NatureWorks Ingeo™ PLA compostable plastic derived from corn grown in the USA and composts in 2-4 months in a commercial facility*)
- ◆ Secure lid fit prevents spills/leakage during transport
- ◆ Lids and bases engineered to securely stack
- ◆ **CUSTOM PRINT PROGRAM:** Customize with your brand and design (up to 2 colors) or choose to emboss

Hot Food Friendly
 Cold Food Friendly

Oil/Water Resistant
 Microwavable

Custom Printing/Embossing
 Renewable Materials

Compostable
 Tree Free

WHY CHOOSE *Simply Responsible*™

MOLDED FIBER PRODUCTS?

THE SIMPLY RESPONSIBLE ADVANTAGE: SUPERIOR DESIGN, FUNCTIONALITY, DURABILITY, & RESPONSIBILITY

- ◆ Crush-resistant
- ◆ Great for hot and cold applications
- ◆ Freezer and microwave safe
- ◆ Grease and cut resistant
- ◆ Molded Fiber Containers handle temperatures up to 200°
- ◆ Lids handle oil and water temperatures up to 150°

Tear-resistant closures

Extra strength sidewall ridge design

Containers and lids designed to securely stack multiple containers

Custom printing available on the top of clamshell containers

Customizable with your brand embossment on all items

Secure lid fit to prevent spills and leakage

 MOLDED FIBER CONTAINERS ARE CERTIFIED COMPOSTABLE AND MADE FROM ANNUALLY RENEWABLE MATERIALS.

PLATES - NATURAL



6" Plate
346673496 – Stock
 Material: Bagasse
 Description: Round, Nested, Natural
 Size: 6.1" x 0.63"
 Case Pack: 500/case (10 bags of 50)
 Dim: 12.9" x 13.1" x 6.8" – Wgt: 9 lbs.
 Cube: 0.67 – TI/Hi: 09/06
 UPC: 842644067977



7" Plate
348287517 – Stock
 Material: Bagasse
 Description: Round, Nested, Natural
 Size: 7.09" x 0.7"
 Case Pack: 500/case (10 bags of 50)
 Dim: 14.8" x 12.6" x 7.7" – Wgt: 11.6 lbs.
 Cube: 0.83 – TI/Hi: 09/06
 UPC: 842644067618



9" Plate
349220534 – Stock
 Material: Bagasse
 Description: Round, Nested, Natural
 Size: 9.06" x 0.78"
 Case Pack: 500/case (10 bags of 50)
 Dim: 18.5" x 13.5" x 9.8" – Wgt: 20.8 lbs.
 Cube: 1.42 – TI/Hi: 07/04
 UPC: 842644067625



Lids: Dome - 345201478

PLATES - NATURAL



9" 3 Compartment Plate
343541577 – Stock
 Material: Bagasse
 Description: Round, Nested, Natural
 Size: 9.06" x 0.79"
 Case Pack: 500/case (10 bags of 50)
 Dim: 18.5" x 13.4" x 9.6" – Wgt: 21.6 lbs.
 Cube: 1.38 – TI/Hi: 07/04
 UPC: 842644067632



Lids: Dome - 345201478



10" Plate
343717914 – Stock
 Material: Bagasse
 Description: Round, Nested, Natural
 Size: 10.24" x 0.79"
 Case Pack: 500/case (10 bags of 50)
 Dim: 20.9" x 13.8" x 10.9" – Wgt: 26.2 lbs.
 Cube: 1.82 – TI/Hi: 05/04
 UPC: 842644068103



10" 3 Compartment Plate
348009237 – Stock
 Material: Bagasse
 Description: Round, Nested, Natural
 Size: 10.24" x 0.77"
 Case Pack: 500/case (10 bags of 50)
 Dim: 20.9" x 13.9" x 10.9" – Wgt: 27.4 lbs.
 Cube: 1.83 – TI/Hi: 05/04
 UPC: 842644068028



SELECT CONTAINERS AVAILABLE IN WHITE

6" Plate
348566855 – Stock

7" Plate
347665913 – Stock

9" Plate
340360734 – Stock

9" 3 Compartment Plate
346315706 – Stock

10" Plate
346503458 – Stock

10" 3 Compartment Plate
344243181 – Stock

10" X 8" Oval Plate
343850514 – Stock

12.5" X 10" Oval Plate
343985369 – Stock

Deep 8" 3 Compartment Plate
340068721 – Stock

Deep 9" 3 Compartment Plate
348331305 – Stock

12 oz. Multipurpose Bowl
341376415 – Stock

16 oz. Multipurpose Bowl
341488777 – Stock

24 oz. Multipurpose Bowl
343731546 – Stock

32 oz. Multipurpose Bowl
345830358 – Stock

32 oz. Rectangle Bowl
344274330 – Stock

48 oz. Rectangle Bowl
347287460 – Stock

6" x 6" Hinged Container
347086607 – Stock

9" x 6" Hinged Container
348760013 – Stock

8" x 8" 3 Compartment Hinged Container
347899687 – Stock

9" x 9" Hinged Container
341121584 – Stock

9" x 9" 3 Compartment Hinged Container
346923952 – Stock



PLATES - NATURAL



10" X 8" Oval Plate
346819038 – Stock

Material: Bagasse

Description: Oval, Nested, Natural

Size: 10.35" x 7.83" x 0.78"

Case Pack: 500/case (10 bags of 50)

Dim: 16.8" x 11.3" x 11.9" – Wgt: 20.2 lbs.

Cube: 1.31 – TI/Hi: 09/03

UPC: 842644067793



12.5" X 10" Oval Plate
347728554 – Stock

Material: Bagasse

Description: Oval, Nested, Natural

Size: 12.48" x 9.98" x 0.97"

Case Pack: 500/case (10 bags of 50)

Dim: 14.1" x 13.1" x 21" – Wgt: 37.4 lbs.

Cube: 2.24 – TI/Hi: 09/02

UPC: 842644067823



Deep 8" 3 Compartment Plate
348313866 – Stock

Capacity: 6/6/18 Fluid oz.

Material: Bagasse

Description: Square, Nested, Natural

Size: 7.95" x 7.95" x 1.89"

Case Pack: 200/case (4 bags of 50)

Dim: 16.4" x 12.3" x 8.8" – Wgt: 14.4 lbs.

Cube: 1.03 – TI/Hi: 09/05

UPC: 842644067656



Lids: Dome - 341102916

PLATES - NATURAL



Deep 9" 3 Compartment Plate
343398984 – Stock

Capacity: 8/8/24 Fluid oz.

Material: Bagasse

Description: Square, Nested, Natural

Size: 8.98" x 8.98" x 1.97"

Case Pack: 200/case (4 bags of 50)

Dim: 18.4" x 12.9" x 9.5" – Wgt: 17.6 lbs.

Cube: 1.30 – TI/Hi: 07/04

UPC: 842644067663



Lids: Dome - 349554587

BOWLS - NATURAL



14 oz. Oval Bowl
340150953 – Stock

Capacity: 14 Fluid oz.

Material: Bagasse

Description: Oval, Nested, Natural

Size: 7.4" x 4.88" x 1.44"

Case Pack: 400/case (8 bags of 50)

Dim: 19.8" x 13.8" x 10.8" – Wgt: 15.2 lbs.

Cube: 1.71 – TI/Hi: 06/04

UPC: 842644067748



Lids: Dome - 343794494



26 oz. Oval Bowl
007605025 – Stock

Capacity: 26 Fluid oz.

Material: Bagasse

Description: Oval, Nested, Natural

Size: 9.29" x 6.65" x 1.6"

Case Pack: 400/case (8 bags of 50)

Dim: 18.9" x 11.6" x 14.3" – Wgt: 21.8 lbs.

Cube: 1.81 – TI/Hi: 08/03

UPC: 842644065805



Lids: Dome - 346684571

BOWLS - NATURAL



12 oz. Multipurpose Bowl

344518866 – Stock

Capacity: 12 Fluid oz.

Material: Bagasse

Description: Round, Nested, Natural

Size: 6.3" x 2.91" x 1.46"

Case Pack: 400/case (8 bags of 50)

Dim: 13.6" x 13.1" x 7" – Wgt: 9.6 lbs.

Cube: 0.72 – TI/Hi: 09/06

UPC: 842644067762



Lids: Flat - 340020833, Dome - 347933656



16 oz. Multipurpose Bowl

340088884 – Stock

Capacity: 16 Fluid oz.

Material: Bagasse

Description: Round, Nested, Natural

Size: 6.3" x 2.91" x 1.95"

Case Pack: 400/case (8 bags of 50)

Dim: 16.9" x 13.4" x 7" – Wgt: 13 lbs.

Cube: 0.92 – TI/Hi: 08/06

UPC: 842644068127



Lids: Flat - 340020833, Dome - 347933656



24 oz. Multipurpose Bowl

340732997 – Stock

Capacity: 24 Fluid oz.

Material: Bagasse

Description: Round, Nested, Natural

Size: 8.05" x 3.78" x 1.74"

Case Pack: 400/case (8 bags of 50)

Dim: 16.5" x 15.5" x 8.9" – Wgt: 20.6 lbs.

Cube: 1.32 – TI/Hi: 06/05

UPC: 842644067984



Lids: Flat - 349210368, Dome - 343881780

Portion - 343400034

BOWLS - NATURAL



32 oz. Multipurpose Bowl

341602645 – Stock

Capacity: 32 Fluid oz.

Material: Bagasse

Description: Round, Nested, Natural

Size: 8.05" x 3.78" x 2.33"

Case Pack: 400/case (8 bags of 50)

Dim: 16.5" x 15.6" x 8.7" – Wgt: 22.6 lbs.

Cube: 1.30 – TI/Hi: 06/05

UPC: 842644068097



Lids: Flat - 349210368, Dome - 343881780

Portion - 343400034



32 oz. Rectangle Bowl

344350796 – Stock

Capacity: 32 Fluid oz.

Material: Bagasse

Description: Rectangular, Nested, Natural

Size: 9.02" x 7.01" x 2.17"

Case Pack: 400/case (8 bags of 50)

Dim: 18.4" x 15.1" x 14.9" – Wgt: 21.8 lbs.

Cube: 2.40 – TI/Hi: 06/03

UPC: 842644067953



Lids: Flat - 349434687, Dome - 346482732

Portion - 348707383



48 oz. Rectangle Bowl

342463795 – Stock

Capacity: 48 Fluid oz.

Material: Bagasse

Description: Rectangular, Nested, Natural

Size: 9.02" x 7.01" x 2.95"

Case Pack: 200/case (8 bags of 50)

Dim: 17.4" x 9.9" x 14.6" – Wgt: 16.2 lbs.

Cube: 1.46 – TI/Hi: 10/03

UPC: 842644067717



Lids: Flat - 349434687, Dome - 346482732

Portion - 348707383

HINGED CONTAINERS - NATURAL



6" x 6" Hinged Container

348481889 – Stock

Capacity: 14 Fluid oz.

Material: Bagasse

Description: Square, Nested, Natural

Size: 6" x 6.1" x 3"

Case Pack: 250/case (5 bags of 50)

Dim: 17.9" x 12.9" x 6.5" – Wgt: 12.8 lbs.

Cube: 0.87 – TI/Hi: 08/07

UPC: 842644067939



9" x 6" Hinged Container

349015126 – Stock

Capacity: 28 Fluid oz.

Material: Bagasse

Description: Rectangular, Nested, Natural

Size: 9" x 6.26" x 2.91"

Case Pack: 250/case (5 bags of 50)

Dim: 18.3" x 13" x 9.6" – Wgt: 18 lbs.

Cube: 1.32 – TI/Hi: 07/04

UPC: 842644067900



8" x 8" Hinged Container

349450668 – Stock

Capacity: 32 Fluid oz.

Material: Bagasse

Description: Square, Nested, Natural

Size: 8" x 8.27" x 2.87"

Case Pack: 200/case (4 bags of 50)

Dim: 16.8" x 16" x 8.6" – Wgt: 19.2 lbs.

Cube: 1.34 – TI/Hi: 06/05

UPC: 842644068219



HINGED CONTAINERS - NATURAL



8" x 8" 3 Compartment Hinged Container

345797806 – Stock

Capacity: 3/3/8 Fluid oz.

Material: Bagasse

Description: Square, Nested, Natural

Size: 8" x 8.27" x 2.87"

Case Pack: 200/case (4 bags of 50)

Dim: 16.8" x 16.3" x 9.6" – Wgt: 19.4 lbs.

Cube: 1.52 – TI/Hi: 06/04

UPC: 842644067878



9" x 9" Hinged Container

346357071 – Stock

Capacity: 44 Fluid oz.

Material: Bagasse

Description: Square, Nested, Natural

Size: 9" x 9.45" x 2.87"

Case Pack: 200/case (4 bags of 50)

Dim: 18.9" x 15.9" x 9.8" – Wgt: 21.8 lbs.

Cube: 1.70 – TI/Hi: 06/04

UPC: 842644067694



9" x 9" 3 Compartment Hinged Container

345001663 – Stock

Capacity: 6/6/10 Fluid oz.

Material: Bagasse

Description: Square, Nested, Natural

Size: 9" x 9.45" x 2.87"

Case Pack: 200/case (4 bags of 50)

Dim: 19.3" x 16" x 9.6" – Wgt: 23 lbs.

Cube: 1.72 – TI/Hi: 05/04

UPC: 842644067915



PET LIDS



9" Plate Lid

345201478 – Stock

Material: PET

Description: Round, Clear, Nested

Size: 9.06" x 2.03"

Case Pack: 200/case (4 bags of 50)

Dim: 18.7" x 14.1" x 18.8" – Wgt: 11 lbs.

Cube: 2.87 – TI/Hi: 06/02

UPC: 842644068042



8" 3 Compartment Deep Plate Lid

341102916 – Stock

Material: PET

Description: Square, Clear, Nested

Size: 7.98" x 7.98" x 1.37"

Case Pack: 200/case (4 bags of 50)

Dim: 16.8" x 14.3" x 17.1" – Wgt: 11.8 lbs.

Cube: 2.38 – TI/Hi: 06/02

UPC: 842644067854



9" 3 Compartment Deep Plate Lid

349554587 – Stock

Material: PET

Description: Square, Clear, Nested

Size: 9" x 9" x 1.37"

Case Pack: 200/case (4 bags of 50)

Dim: 18.8" x 14.9" x 18.9" – Wgt: 13 lbs.

Cube: 3.06 – TI/Hi: 06/02

UPC: 842644068004



PET LIDS



14 oz. Oval Bowl Dome Lid

343794494 – Stock

Material: PET

Description: Oval, Clear, Nested

Size: 7.95" x 5.24" x 1.38"

Case Pack: 400/case (8 bags of 50)

Dim: 22.2" x 11.2" x 16.5" – Wgt: 8.4 lbs.

Cube: 2.37 – TI/Hi: 06/02

UPC: 842644067960



26 oz. Oval Bowl Dome Lid

346684571 – Stock

Material: PET

Description: Oval, Clear, Nested

Size: 9.45" x 6.69" x 1.38"

Case Pack: 400/case (8 bags of 50)

Dim: 22.3" x 14.4" x 19.1" – Wgt: 15.8 lbs.

Cube: 3.55 – TI/Hi: 05/02

UPC: 842644067816



12/16 oz. Multipurpose Bowl Flat Lid

340020833 – Stock

Material: PET

Description: Round, Clear, Nested

Size: 6.46" x 0.41"

Case Pack: 400/case (8 bags of 50)

Dim: 25.9" x 9.4" x 14" – Wgt: 9.4 lbs.

Cube: 1.97 – TI/Hi: 06/03

UPC: 842644068073



PET LIDS



32/48 oz. Rectangular Bowl Flat Lid 349434687 – Stock

Material: PET
Description: Rectangular, Clear, Nested
Size: 9.08" x 7.07" x 0.35"
Case Pack: 200/case (4 bags of 50)
Dim: 18" x 10" x 15.3" – Wgt: 8.8 lbs.
Cube: 1.59 – TI/Hi: 10/03
UPC: 842644067892



24/32 oz. Multipurpose Bowl Flat Lid 349210368 – Stock

Material: PET
Description: Round, Clear, Nested
Size: 8.19" x 0.41"
Case Pack: 200/case (4 bags of 50)
Dim: 17.1" x 7.7" x 17.1" – Wgt: 7.2 lbs.
Cube: 1.30 – TI/Hi: 14/02
UPC: 842644067755



24/32 oz. Multipurpose Bowl Dome Lid 343881780 – Stock

Material: PET
Description: Round, Clear, Nested
Size: 8.19" x 1.38"
Case Pack: 200/case (4 bags of 50)
Dim: 17.1" x 13.5" x 17.5" – Wgt: 9.2 lbs.
Cube: 2.34 – TI/Hi: 08/02
UPC: 842644068196



PET LIDS



32/48 oz. Rectangular Bowl Flat Lid 349434687 – Stock

Material: PET
Description: Rectangular, Clear, Nested
Size: 9.08" x 7.07" x 0.35"
Case Pack: 200/case (4 bags of 50)
Dim: 18" x 10" x 15.3" – Wgt: 8.8 lbs.
Cube: 1.59 – TI/Hi: 10/03
UPC: 842644067892



INNOVATIVE PORTION CUP FRIENDLY LIDS AVAILABLE

KEEPING PORTION CUPS OUT OF THE FOOD

Tired of portion cups being loose in a bag or placing them in the container with the food? We have a solution for you. These innovative lids with portion cup holders are designed to solve those problems.

- ♦ Patented* design securely holds 2 oz. portion cups
- ♦ Round lid fits 24 and 32 oz. bowls
- ♦ Rectangle lid fits 32 and 48 oz. rectangle bowls



* Patent D835,459

PET LIDS



32/48 oz. Rectangular Bowl Dome Lid 346482732 – Stock

Material: PET
Description: Rectangular, Clear, Nested
Size: 9.08" x 7.07" x 1.26"
Case Pack: 200/case (4 bags of 50)
Dim: 15.3" x 13" x 19.5" – Wgt: 10 lbs.
Cube: 2.24 – TI/Hi: 09/02
UPC: 842644067885



24/32 oz. Multipurpose Bowl Dome Lid w/2 oz. Cup Holder 343400034 – Stock

Material: PET
Description: Round, Clear, Nested
Size: 8.19" x 1.38"
Case Pack: 200/case (4 bags of 50)
Dim: 17.1" x 13.6" x 17.9" – Wgt: 10.8 lbs.
Cube: 2.41 – TI/Hi: 08/02
UPC: 842644068561



32/48 oz. Rectangular Bowl Dome Lid w/2 oz. Cup Holder 348707383 – Stock

Material: PET
Description: Rectangular, Clear, Nested
Size: 9.08" x 7.07" x 1.26"
Case Pack: 200/case (4 bags of 50)
Dim: 25.6" x 10" x 15.4" – Wgt: 12.2 lbs.
Cube: 2.28 – TI/Hi: 06/03
UPC: 842644068578





- ◆ ON TREND DESIGN perfect for any food service, grocery store, or convenience store application
- ◆ Comprehensive family of matched carryout packaging includes: Carryout Cartons, Soup Cups, Buckets, Deli Bags, Rotisserie Bags, Fried Chicken Bags, and Meal Solutions Carryout Bags
- ◆ Carryout cartons are automatic
- ◆ Cartons are available in Kraft and SBS, soup cups are available in SBS, and buckets are available in a mix of Kraft and SBS
- ◆ Matching stock family of bakery packaging
- ◆ **CUSTOM PRINT PROGRAM:** Customize eligible items with your brand and design
- ◆ Low minimum custom print runs with 12 week lead time from receipt of approved artwork

 Hot Food Friendly

 Leak Resistant

 Custom Printing

 Recyclable Item*

 Cold Food Friendly

 Microwavable

*If clean and dry
Recyclability varies by item type
Check with your local municipality/store

CARRYOUT CARTONS - KRAFT



7" x 4.25" x 2.75" Carton - Fresh Flavor™

016000203 – Stock

♦ CUSTOM PRINT PROGRAM MIN: 15,000 pcs.

Material: CCSUS

Description: Tuck Top AB

Size: 7" x 4.25" x 2.75"

Pack: 250/case

Dim.: 16.5" x 9.2" x 12" – Wgt: 18.21 lbs.

Cube: 1.05 – TI/Hi: 13/03

UPC: 842644063436



9" x 5" x 3" Carton - Fresh Flavor™

016100203 – Stock

♦ CUSTOM PRINT PROGRAM MIN: 15,000 pcs.

Material: CCSUS

Description: Tuck Top AB

Size: 9" x 5" x 3"

Case Pack: 250/case

Dim.: 16.5" x 9.5" x 14.5" – Wgt: 28.08 lbs.

Cube: 1.32 – TI/Hi: 12/03

UPC: 842644063412



9.5" x 5" x 5" Carton - Fresh Flavor™

016200204 – Stock

♦ CUSTOM PRINT PROGRAM MIN: 15,000 pcs.

Material: CCSUS

Description: Handled Top FFAB

Size: 9.5" x 5" x 5"

Case Pack: 100/case

Dim.: 12" x 11.9" x 15.6" – Wgt: 22.2 lbs.

Cube: 1.29 – TI/Hi: 12/03

UPC: 842644063351



CARRYOUT CARTONS - KRAFT



8" x 6" x 8" Carton - Fresh Flavor™

016300203 – Stock

♦ CUSTOM PRINT PROGRAM MIN: 15,000 pcs.

Material: CCSUS

Description: Handled Top FFAB

Size: 8" x 6" x 8"

Case Pack: 100/case

Dim.: 14" x 12" x 15" – Wgt: 26.2 lbs.

Cube: 1.46 – TI/Hi: 11/03

UPC: 842644063337



CARRYOUT CARTONS - SBS



7" x 4.25" x 2.75" Carton - Fresh Flavor™

006000203 – Stock

♦ CUSTOM PRINT PROGRAM MIN: 15,000 pcs.

Material: SBS

Description: Tuck Top AB

Size: 7" x 4.25" x 2.75"

Case Pack: 250/case

Dim.: 16.5" x 9" x 12.1" – Wgt: 16.6 lbs.

Cube: 1.04 – TI/Hi: 13/03

UPC: 842644063443



9" x 5" x 3" Carton - Fresh Flavor™

006100203 – Stock

♦ CUSTOM PRINT PROGRAM MIN: 15,000 pcs.

Material: SBS

Description: Tuck Top AB

Size: 9" x 5" x 3"

Case Pack: 250/case

Dim.: 16.5" x 9.5" x 14.5" – Wgt: 25.18 lbs.

Cube: 1.32 – TI/Hi: 12/03

UPC: 842644063429



CARRYOUT CARTONS - SBS



9.5" x 5" x 5" Carton - Fresh Flavor™

006200204 – Stock

♦ CUSTOM PRINT PROGRAM MIN: 15,000 pcs.

Material: SBS

Description: Handled Top FFAB

Size: 9.5" x 5" x 5"

Case Pack: 100/case

Dim.: 11.9" x 10.9" x 15.5" – Wgt: 20.2 lbs.

Cube: 1.16 – TI/Hi: 12/03

UPC: 842644063368



8" x 6" x 8" Carton - Fresh Flavor™

006300204 – Stock

♦ CUSTOM PRINT PROGRAM MIN: 15,000 pcs.

Material: SBS

Description: Handled Top FFAB

Size: 8" x 6" x 8"

Case Pack: 100/case

Dim.: 14" x 12" x 15.1" – Wgt: 25.8 lbs.

Cube: 1.48 – TI/Hi: 11/03

UPC: 842644063344



SOUP CUPS - SBS - BULK



8 oz. Soup Cup - Fresh Flavor™

195071224 – Stock

♦ CUSTOM PRINT PROGRAM MIN: 10,000

Material: SBS, Poly Coated Inside

Description: Bulk Pack

Size: 8 oz.

Case Pack: 500/case

Dim.: 20" x 8.2" x 23.1" – Wgt: 12.24 lbs.

Cube: 2.19 – TI/Hi: 12/04

UPC: 842644064020



Lids: Small Paper - 193955484, Small PP - 198058607

SOUP CUPS - SBS - BULK



10 oz. Soup Cup - Fresh Flavor™
199155802 – Stock

♦ **CUSTOM PRINT PROGRAM MIN: 10,000**

Material: SBS, Poly Coated Inside

Description: Bulk Pack

Size: 10 oz.

Case Pack: 500/case

Dim.: 20" x 8.1" x 21.7" – Wgt: 13.34 lbs.

Cube: 2.03 – TI/Hi: 12/04

UPC: 842644063849



Lids: Small Paper - 193955484, Small PP - 198058607



12 oz. Soup Cup - Fresh Flavor™
196256252 – Stock

♦ **CUSTOM PRINT PROGRAM MIN: 10,000**

Material: SBS, Poly Coated Inside

Description: Bulk Pack

Size: 12 oz.

Case Pack: 500/case

Dim.: 20" x 8.2" x 22.5" – Wgt: 10.8 lbs.

Cube: 2.14 – TI/Hi: 12/04

UPC: 842644063771



Lids: Small Paper - 193955484, Small PP - 198058607



16 oz. Tall Soup Cup - Fresh Flavor™
193759666 – Stock

♦ **CUSTOM PRINT PROGRAM MIN: 10,000**

Material: SBS, Poly Coated Inside

Description: Bulk Pack

Size: 16 oz. Tall

Case Pack: 500/case

Dim.: 20" x 8.2" x 25" – Wgt: 12.6 lbs.

Cube: 2.37 – TI/Hi: 12/03

UPC: 842644063825



Lids: Small Paper - 193955484, Small PP - 198058607

SOUP CUPS - SBS - BULK



16 oz. Squat Soup Cup - Fresh Flavor™
193848164 – Stock

♦ **CUSTOM PRINT PROGRAM MIN: 10,000**

Material: SBS, Poly Coated Inside

Description: Bulk Pack

Size: 16 oz. Squat

Case Pack: 500/case

Dim.: 23.6" x 10" x 26.8" – Wgt: 19.8 lbs.

Cube: 3.66 – TI/Hi: 08/03

UPC: 842644064051



Lids: Large Paper - 195354696, Large PP - 191444534



32 oz. Soup Cup - Fresh Flavor™
194581169 – Stock

♦ **CUSTOM PRINT PROGRAM MIN: 10,000**

Material: SBS, Poly Coated Inside

Description: Bulk Pack

Size: 32 oz.

Pack: 500/case

Dim.: 23.5" x 9.7" x 27.8" – Wgt: 25.22 lbs.

Cube: 3.67 – TI/Hi: 08/03

UPC: 842644063948



Lids: Large Paper - 195354696, Large PP - 191444534



10 oz. Soup Cup w/Paper Lid - Fresh Flavor™
195127982 – Stock

♦ **CUSTOM PRINT PROGRAM MIN: 10,000**

Material: SBS, Poly Coated Inside

Description: Combo Pack

Size: 10 oz.

Case Pack: 250/case

Dim.: 20.5" x 8.6" x 28.2" – Wgt: 11.8 lbs.

Cube: 2.88 – TI/Hi: 10/03

UPC: 842644063856



SOUP CUPS - SBS - COMBO PACKS



12 oz. Soup Cup w/Paper Lid - Fresh Flavor™
199847604 – Stock

♦ **CUSTOM PRINT PROGRAM MIN: 10,000**

Material: SBS, Poly Coated Inside

Description: Combo Pack

Size: 12 oz.

Case Pack: 250 sets/case

Dim.: 20.5" x 8.6" x 28.2" – Wgt: 12 lbs.

Cube: 2.88 – TI/Hi: 10/03

UPC: 842644063788



16 oz. Soup Cup w/Paper Lid - Fresh Flavor™
195527680 – Stock

♦ **CUSTOM PRINT PROGRAM MIN: 10,000**

Material: SBS, Poly Coated Inside

Description: Combo Pack

Size: 16 oz. Tall

Case Pack: 250 sets/case

Dim.: 20.5" x 8.5" x 28.7" – Wgt: 12.8 lbs.

Cube: 2.89 – TI/Hi: 10/03

UPC: 842644063801



32 oz. Soup Cup w/Paper Lid - Fresh Flavor™
198209164 – Stock

♦ **CUSTOM PRINT PROGRAM MIN: 10,000 pcs.**

Material: SBS, Poly Coated Inside

Description: Combo Pack

Size: 32 oz.

Case Pack: 250 sets/case

Dim.: 24.4" x 9.8" x 32.3" – Wgt: 20.83 lbs.

Cube: 4.47 – TI/Hi: 08/03

UPC: 842644065072



SOUP CUPS - SBS - COMBO PACKS



10oz. Soup Cup w/PP Lid - Fresh Flavor™
199930612 – Stock

♦ **CUSTOM PRINT PROGRAM MIN: 10,000 pcs.**

Material: SBS, Poly Coated Inside, PP

Description: Combo Pack

Size: 10 oz.

Case Pack: 250 sets/case

Dim.: 20" x 8.1" x 20.5" – Wgt: 7.94 lbs.

Cube: 1.92 – TI/Hi: 12/04

UPC: 842644063863



*Lid only



12 oz. Soup Cup w/PP Lid - Fresh Flavor™
192946783 – Stock

♦ **CUSTOM PRINT PROGRAM MIN: 10,000 pcs.**

Material: SBS, Poly Coated Inside, PP

Description: Combo Pack

Size: 12 oz.

Case Pack: 250 sets/case

Dim.: 20" x 8.2" x 20.5" – Wgt: 8.6 lbs.

Cube: 1.95 – TI/Hi: 12/04

UPC: 842644063795



*Lid only



16 oz. Squat Soup Cup w/PP Lid - Fresh Flavor™
194495736 – Stock

♦ **CUSTOM PRINT PROGRAM MIN: 10,000 pcs.**

Material: SBS, Poly Coated Inside, PP

Description: Combo Pack

Size: 16 oz. Squat

Case Pack: 250 sets/case

Dim.: 24.5" x 9.8" x 23" – Wgt: 14 lbs.

Cube: 3.20 – TI/Hi: 08/04

UPC: 842644063818



*Lid only

SOUP CUPS - SBS - COMBO PACKS



32 oz. Soup Cup w/PP Lid - Fresh Flavor™
196534034 – Stock

♦ **CUSTOM PRINT PROGRAM MIN: 10,000 pcs.**

Material: SBS, Poly Coated Inside, PP

Description: Combo Pack

Size: 32 oz.

Case Pack: 250 sets/case

Dim.: 24.4" x 9.8" x 24.4" – Wgt: 15.43 lbs.

Cube: 3.38 – TI/Hi: 08/04

UPC: 842644064044



*Lid only

PAPER LIDS - SBS



Small White Paper Lid
193955484 – Stock

Material: SBS, Poly Coated Inside

Description: Bulk Pack

Size: 6/8, 8/10, 12, 16T oz.

Case Pack: 500/case

Dim: 20.5" x 8.8" x 30.3" – Wgt: 12.4 lbs.

Cube: 3.18 – TI/Hi: 10/03

UPC: 842644034566



Large White Paper Lid
195354696 – Stock

Material: SBS, Poly Coated Inside

Description: Bulk Pack

Size: 16S, 24, 32 oz.

Case Pack: 500/case

Dim: 24.4" x 10" x 30" – Wgt: 15.4 lbs.

Cube: 4.24 – TI/Hi: 08/03

UPC: 842644034573



PP LIDS



Small PP Lid Bulk
198058607 – Stock

Material: PP

Description: Bulk Pack

Size: 6/8, 8/10, 12, 16T oz.

Case Pack: 500/case

Dim: 20.5" x 8.7" x 15.5" – Wgt: 6.2 lbs.

Cube: 1.60 – TI/Hi: 10/03

UPC: 842644034580



Large PP Lid Bulk
191444534 – Stock

Material: PP

Description: Bulk Pack

Size: 16S, 24, 32 oz.

Case Pack: 500/case

Dim: 24.2" x 10" x 15.1" – Wgt: 7.6 lbs.

Cube: 2.14 – TI/Hi: 08/03

UPC: 842644034597



BUCKETS - BULK



54 oz. Kraft Short Bucket - Fresh Flavor™
195074181 – Stock

♦ **CUSTOM PRINT PROGRAM MIN: 10,000 pcs.**

Material: Kraft, Poly Coated Inside

Description: Bulk

Size: 54 oz.

Case Pack: 165/case

Dim.: 23" x 7.7" x 22.8" – Wgt: 13.19 lbs.

Cube: 2.34 – TI/Hi: 10/04

UPC: 842644064372



Lids: Paper - 196069468, Dome PP - 191168207,
Flat PP - 193208817

BUCKETS - BULK



54 oz. SBS Short Bucket - Fresh Flavor™
193926641 – Stock

♦ **CUSTOM PRINT PROGRAM MIN: 10,000 pcs.**

Material: SBS, Poly Coated Inside

Description: Bulk Pack

Size: 54 oz.

Case Pack: 165/case

Dim.: 23" x 8" x 23" – Wgt: 12.19 lbs.

Cube: 2.45 – TI/Hi: 10/04

UPC: 842644064037



Lids: Paper - 196069468, Dome PP - 191168207,
Flat PP - 193208817



85 oz. Bucket - Fresh Flavor™
198389703 – Stock

♦ **CUSTOM PRINT PROGRAM MIN: 10,000 pcs.**

Material: SBS, Poly Coated Inside

Description: Bulk Pack, with Ridge

Size: 85 oz.

Case Pack: 200/case

Dim.: 15.4" x 15.4" x 23.8" – Wgt: 19.62 lbs.

Cube: 3.27 – TI/Hi: 06/04

UPC: 842644064013



Lids: Paper - 196069468, Dome PP - 191168207,
Flat PP - 193208817



130 oz. Bucket - Fresh Flavor™
196496866 – Stock

♦ **CUSTOM PRINT PROGRAM MIN: 10,000 pcs.**

Material: SBS, Poly Coated Inside

Description: Bulk Pack, with Ridge

Size: 130 oz.

Case Pack: 200/case

Dim.: 17.3" x 17.3" x 28.7" – Wgt: 26.26 lbs.

Cube: 4.97 – TI/Hi: 04/03

UPC: 842644063924



Lids: 130 oz. Paper - 192708717

BUCKETS - BULK



170 oz. Bucket - Fresh Flavor™
198562751 – Stock

♦ **CUSTOM PRINT PROGRAM MIN: 10,000 pcs.**

Material: SBS, Poly Coated Inside

Description: Bulk Pack, with Ridge

Size: 170 oz.

Case Pack: 100/case

Dim.: 18.1" x 18.1" x 18.9" – Wgt: 17.05 lbs.

Cube: 3.58 – TI/Hi: 04/05

UPC: 842644063931



Lids: 170 oz. Paper - 193428926



42/44/54/85 oz. PP Bucket Lid
191168207 – Stock

Material: PP

Description: Bulk Pack, Anti Fog, Vented

Fits Size: 42, 44, 54, 85 oz.

Case Pack: 360/case

Dim.: 23.2" x 15.7" x 16.1" – Wgt: 16.6 lbs.

Cube: 3.39 – TI/Hi: 05/03

UPC: 842644030520



42/44/54/85 oz. Flat PP Bucket Lid
193208817 – Stock

Material: PP

Description: Bulk Pack, Anti Fog, Non-Vented

Fits Size: 42, 44, 54, 85 oz.

Case Pack: 360/case

Dim.: 24.5" x 16.8" x 15.1" – Wgt: 14.33 lbs.

Cube: 3.6 – TI/Hi: 04/03

UPC: 842644071189



BUCKET LIDS - BULK



54/85 oz. Bucket Paper Lid
196069468 – Stock

Material: SBS, Poly Coat

Description: Bulk Pack, White, Inset Lid w/Coating

Size: 54/85 oz.

Case Pack: 200/case

Dim.: 7.6" x 7.8" x 7.7" – Wgt: 7.61 lbs.

Cube: 0.26 – TI/Hi: 30/06

UPC: 842644039455



130 oz. Bucket Paper Lid
192708717 – Stock

Material: SBS, Poly Coat

Description: Bulk Pack, White, Inset Lid w/Coating

Size: 130 oz.

Case Pack: 200/case

Dim.: 8.7" x 8.6" x 7.7" – Wgt: 9.6 lbs.

Cube: 0.33 – TI/Hi: 20/06

UPC: 842644039448



170 oz. Bucket Paper Lid
193428926 – Stock

Material: SBS, Poly Coat

Description: Bulk Pack, White, Inset Lid w/Coating

Size: 170 oz.

Case Pack: 200/case

Dim.: 9.3" x 9.3" x 7.5" – Wgt: 10.58 lbs.

Cube: 0.38 – TI/Hi: 20/06

UPC: 842644041267



BUCKET DIVIDERS



85 oz. Bucket Divider

261311183 – Make & Ship

♦ **CUSTOM PRINT PROGRAM MIN: 50,000 pcs.**

Material: SBS

Description: 3-way Insert, Plain

Size: Small Bucket Insert Divider

Case Pack: 200/case

Dim: 8.4" x 7.6" x 5.7" – Wgt: 5.07 lbs.

Cube: 0.21 – TI/HI: 25/08

UPC: 842644052126



130 oz. Bucket Divider

012660047 – Make & Ship

♦ **CUSTOM PRINT PROGRAM MIN: 10,000 pcs.**

Material: SBS

Description: 3-way Insert, Plain

Size: Medium Bucket Insert Divider

Case Pack: 200/case

Dim: 11" x 6.3" x 8.1" – Wgt: 6.7 lbs.

Cube: 0.32 – TI/HI: 27/05

UPC: 842644057862



170 oz. Bucket Divider

014474227 – Make & Ship

♦ **CUSTOM PRINT PROGRAM MIN: 10,000 pcs.**

Material: SBS

Description: 3-way Insert, Plain

Size: Large Bucket Insert Divider

Case Pack: 200/case

Dim: 11" x 8.3" x 9.1" – Wgt: 7.92 lbs.

Cube: 0.48 – TI/HI: 19/05

UPC: 842644057855



RESEALABLE DELI BAGS



10" x 8" LD Zip Bag - Fresh Flavor™

302926543 – Stock

♦ **CUSTOM PRINT PROGRAM MIN: 72,000 pcs.**

Material: High Clarity LDPE

Description: Top Load, Saddle Style

Size: 10" x 8"

Case Pack: 1,000/case

Dim.: 10.2" x 8.2" x 10.7" – Wgt: 9.6 lbs.

Cube: 0.52 – TI/HI: 24/04

UPC: 842644063535



10.75" x 8" LD Slide Bag - Fresh Flavor™

302000203 – Stock

♦ **CUSTOM PRINT PROGRAM MIN: 72,000 pcs.**

Material: High Clarity LDPE

Description: Bottom Load, Header Style

Size: 10.75" x 8"

Case Pack: 1,000/case

Dim.: 15.5" x 11.6" x 9.5" – Wgt: 14.6 lbs.

Cube: 0.99 – TI/HI: 10/04

UPC: 842644063542



10.75" x 8" LD Slide Bag - Fresh Flavor™

344594912 – Stock

♦ **CUSTOM PRINT PROGRAM MIN: 72,000 pcs.**

Material: High Clarity LDPE

Description: Top Load, Header Style

Size: 10.75" x 8"

Case Pack: 1,000/case

Dim.: 15.7" x 11.5" x 9.5" – Wgt: 13.4 lbs.

Cube: 0.99 – TI/HI: 10/04

UPC: 842644066888



FLIP-TOP DELI BAGS



8.5" x 8.5" HD Flip-Top Bag - Fresh Flavor™

234000204 – Stock

♦ **CUSTOM PRINT PROGRAM MIN: 100,000 pcs.**

Material: Clear Embossed HDPE

Description: Flip Top, Saddle Pack

Size: 8.5" x 8.5"

Case Pack: 2,000/case

Dim.: 11.1" x 10" x 3.1" – Wgt: 5.2 lbs.

Cube: 0.20 – TI/HI: 15/15

UPC: 842644063658



10.5" x 9.5" HD Flip-Top Bag - Fresh Flavor™

343023409 – Stock

♦ **CUSTOM PRINT PROGRAM MIN: 100,000 pcs.**

Material: Clear Embossed HDPE

Description: Flip Top, Saddle Pack

Size: 10.5" x 9.5"

Case Pack: 2,000/case

Dim.: 12.2" x 11.4" x 3" – Wgt: 7.93 lbs.

Cube: 0.24 – TI/HI: 12/15

UPC: 842644064099



6" x 4" x 14" HD Bag - Fresh Flavor™

211200204 – Stock

♦ **CUSTOM PRINT PROGRAM MIN: 50,000 pcs.**

Material: White Smooth HDPE

Description: Loose Pack

Size: 6" x 4" x 14"

Case Pack: 1,000/case

Dim.: 12.6" x 8" x 4.3" – Wgt: 8 lbs.

Cube: 0.25 – TI/HI: 18/10

UPC: 842644063962



HOT FOOD DELI BAGS



7" x 3" x 11" + 1" HD Bag - Fresh Flavor™

212100203 ♦ Stock

♦ CUSTOM PRINT PROGRAM MIN: 50,000 pcs.

Material: White Smooth HDPE

Description: Standard Header Style 5

Size: 7" x 3" x 11" + 1"

Case Pack: 1,000/case

Dim.: 12.7" x 8" x 4.5" – Wgt: 6.6 lbs.

Cube: 0.26 – TI/Hi: 19/10

UPC: 842644063986



7" x 4" x 14" + 1" HD Bag - Fresh Flavor™

212400203 ♦ Stock

♦ CUSTOM PRINT PROGRAM MIN: 50,000 pcs.

Material: White Smooth HDPE

Description: Standard Header Style 5

Size: 7" x 4" x 14" + 1"

Case Pack: 1,000/case

Dim.: 15.7" x 7.9" x 4.1" – Wgt: 10.2 lbs.

Cube: 0.29 – TI/Hi: 15/11

UPC: 842644064006



MEAL SOLUTIONS CARRYOUT BAGS



14" x 10" x 15" x 10" Rigid Handled Shopper - Fresh Flavor™

264867156 – Stock

♦ CUSTOM PRINT PROGRAM MIN: 25,000 pcs.

Material: White Smooth PPPE

Description: Flat Bottom, Insert, 1CF/1CB

Size: 14" x 10" x 15" x 10"

Case Pack: 100/case

Dim.: 17.7" x 15.5" x 7.2" – Wgt: 19.18 lbs.

Cube: 1.14 – TI/Hi: 06/06

UPC: 842644065171



MEAL SOLUTIONS CARRYOUT BAGS



22" x 14" x 15" x 14" Rigid Handled Shopper - Fresh Flavor™

266241106 – Stock

♦ CUSTOM PRINT PROGRAM MIN: 25,000 pcs.

Material: White Smooth PPPE

Description: Flat Bottom, Insert, 1CF/1CB

Size: 22" x 14" x 15" x 14"

Case Pack: 50/case

Dim.: 23" x 18.1" x 5" – Wgt: 20 lbs.

Cube: 1.20 – TI/Hi: 04/09

UPC: 842644065164



11.5" x 10.5" x 20" x 10.5" HD Square Bottom T-shirt Bag - Fresh Flavor™

268106256 – Stock

♦ CUSTOM PRINT PROGRAM MIN: 50,000 pcs.

Material: White Smooth HDPE

Description: T-Shirt Bag Style, 1CF/1CB

Size: 11.5" x 10.5" x 20" x 10.5"

Case Pack: 250/case

Dim.: 12.5" x 11.7" x 5.6" – Wgt: 8.6 lbs.

Cube: 0.47 – TI/Hi: 12/08

UPC: 842644065188



BAG RACKS



T-shirt Bag Rack

297271063 – Stock

Material: Metal

Description: T-Shirt Bag Style

Size: Standard

Case Pack: 2/case

Dim.: 15.4" x 15.2" x 15.5" – Wgt: 9.6 lbs.

Cube: 2.10 – TI/Hi: 06/03

UPC: 842644026059

BAG RACKS



A-Frame Rack

297413670 – Stock

Material: Aluminum

Description: A-Frame Rack

Size: 8" x 6.1875" x 12"

Case Pack: 2/case

Dim.: 14.2" x 8.3" x 8.5" – Wgt: 8 lbs.

Cube: 0.58 – TI/Hi: 14/05

UPC: 842644019174



5" Header Bag Rack

290367240 – Stock

Material: Aluminum

Description: Header Style 5, Black

Size: 5"

Case Pack: 1/case

UPC: 842644025939



T Bar Rack

290522864 – Stock

Material: Aluminum w/Plastic Hook

Description: T Bar Rack, White

Size: Small

Case Pack: 1/case

UPC: 842644025953

WHY CHOOSE ROTISSERIE BAGS OVER DOMES?

ROTISSERIE BAGS ARE EASY TO USE, EFFICIENT, AND SAVE YOU MONEY.

Save time and space by switching to Inno-Pak's Rotisserie Bags. These durable bags are warming table and microwave friendly, and take up a fraction of the space a standard dome does.

- ◆ A single truckload of Inno-Pak Rotisserie Bags is equal to over 10 truckloads of domes
- ◆ Smaller cases equals lighter cases with a much smaller storage footprint

THE NUMBERS DON'T LIE:

ROTISSERIE BAGS

- ◆ Case Pack: **250 bags**
- ◆ Cases/Pallett: **105**
- ◆ Units/Truck: **1,470,000**
- ◆ Case Cube: **0.51**
- ◆ Case Wgt: **8.4 lbs.**

DOME #1

- ◆ Case Pack: 170 pcs.
- ◆ Cases/Pallett: 24
- ◆ Units/Truck: 114,240
- ◆ Case Cube: 3.97
- ◆ Case Wgt: 20.18 lbs.

DOME #2

- ◆ Case Pack: 100 pcs.
- ◆ Cases/Pallett: 30
- ◆ Units/Truck: 84,000
- ◆ Case Cube: 3.47
- ◆ Case Wgt: 12 lbs.

DOME #3

- ◆ Case Pack: 100 pcs.
- ◆ Cases/Pallett: 30
- ◆ Units/Truck: 168,000
- ◆ Case Cube: 1.95
- ◆ Case Wgt: 13.11 lbs.

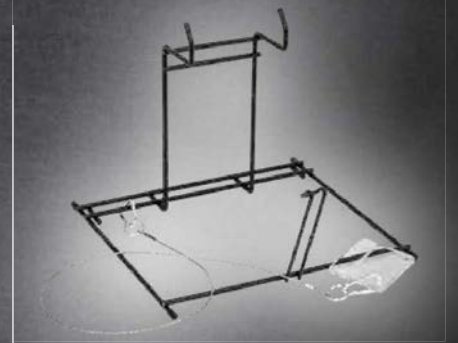

Mat Black Counter Top Rack includes Quick Closer Tool and Tether for efficiency.

- 297144062** – Counter Top Rack Kit with Quick Closer Tool and Tether
- 346950056** – Quick Closer Tool

ROTISSERIE CHICKEN BAGS



Half Rotisserie/Sections Bag **263985648** – Stock

◆ **CUSTOM PRINT PROGRAM MIN: 100,000 pcs.**

Material: Clear, Anti-fog PET/CPP

Description: Header Bag, Zipper, Vented, 2CF/2CB

Size: 11.5" x 5" + 5.5" + 1.5"

Case Pack: 250/case

Dim: 11.8" x 8.6" x 6.3" – Wgt: 6.5 lbs.

Cube: 0.37 – TI/Hi: 18/07

UPC: 842644072551



Rotisserie Chicken Bag **264204538** – Stock

◆ **CUSTOM PRINT PROGRAM MIN: 100,000 pcs.**

Material: Clear, Anti-fog PET/CPP

Description: Header Bag, Zipper, Vented, 2CF/2CB

Size: 12.75" x 6.75" + 5.5" + 1.5"

Case Pack: 250/case

Dim: 13.5" x 9.7" x 6.5" – Wgt: 8.4 lbs.

Cube: 0.49 – TI/Hi: 15/07

UPC: 842644063399



Large Rotisserie Chicken Bag **268261349** – Stock

◆ **CUSTOM PRINT PROGRAM MIN: 100,000 pcs.**

Material: Clear, Anti-fog PET/CPP

Description: Header Bag, Zipper, Vented, 2CF/2CB

Size: 13.25" x 7" + 6.5" + 1.5"

Case Pack: 250/case

Dim: 14" x 10.6" x 6.5" – Wgt: 9 lbs.

Cube: 0.56 – TI/Hi: 11/07

UPC: 842644067144



FRIED CHICKEN BAGS



4 pc. Fried Chicken Bag **262078881** – Stock

◆ **CUSTOM PRINT PROGRAM MIN: 100,000 pcs.**

Material: Clear, Anti-fog PET/CPP

Description: Header Bag, Zipper, Vented, 2CF/2CB

Size: 9" x 6.5" + 5" + 1.5"

Case Pack: 250/case

Dim: 9.8" x 9.8" x 6.7" – Wgt: 6 lbs.

Cube: 0.37 – TI/Hi: 16/07

UPC: 842644063382



8 pc. Fried Chicken Bag **268245158** – Stock

◆ **CUSTOM PRINT PROGRAM MIN: 100,000 pcs.**

Material: Clear, Anti-fog PET/CPP

Description: Header Bag, Zipper, Vented, 2CF/2CB

Size: 14" x 7" + 5.5" + 1.5"

Case Pack: 250/case

Dim: 14.5" x 11" x 9" – Wgt: 12.8 lbs.

Cube: 0.83 – TI/Hi: 11/05

UPC: 842644067076



12 pc. Fried Chicken Bag **266165691** – Stock

◆ **CUSTOM PRINT PROGRAM MIN: 100,000 pcs.**

Material: Clear, Anti-fog PET/CPP

Description: Header Bag, Zipper, Vented, 2CF/2CB

Size: 17" x 7.5" + 7" + 1.5"

Case Pack: 250/case

Dim: 17.4" x 11.7" x 7.9" – Wgt: 12.8 lbs.

Cube: 0.93 – TI/Hi: 08/05

UPC: 842644067083





- ◆ Delivery, carryout, dine-in, or otherwise, these pizza cartons always deliver a fresh, hot, and tasty experience
- ◆ All cartons come with a grease-resistant barrier
- ◆ Serve up delicious pizza, strombolis, calzones, and more with easy-to-assemble Lock Corner Pizza Boxes 8” to 16” in size
- ◆ Grab life by the slice with the Single Slice Pizza Carton, featuring anti-fog, PP window, secure closure, and designed for a slice of 14” pizza
- ◆ Get personal with 7” Multipurpose Cartons with anti-fog, PP windows, perfect for personal pizzas
- ◆ **CUSTOM PRINT PROGRAM:** Customize eligible products with your brand and design
- ◆ Low minimum custom print runs with 12 week lead time from receipt of approved artwork
- ◆ **[Ask for more information on these great products at innopak.com/contact](http://innopak.com/contact)**

 Hot Food Friendly

 Microwavable

 Custom Printing

 Recyclable Item*
*Check with your local municipality/store

 Cold Food Friendly

LOCK CORNER PIZZA BOXES



8" Pizza Box White Plain

341850710 – Stock

Material: CCSUS (Kraft In/White Out)

Description: Pizza Box Plain White

Size: 8" x 8" x 1.5"

Case Pack: 100/case

Dim: 20.7" x 11.3" x 2.2" – Wgt: 5.70 lbs.

Cube: 0.30 – TI/Hi: 06/17

UPC: 842644072650



9" Pizza Box White Plain

346345705 – Stock

Material: CCSUS (Kraft In/White Out)

Description: Pizza Box Plain White

Size: 9" x 9" x 1.5"

Case Pack: 100/case

Dim: 22.8" x 12.6" x 2.2" – Wgt: 7.70 lbs.

Cube: 0.37 – TI/Hi: 06/21

UPC: 842644072657



10" Pizza Box White Plain

348652033 – Stock

Material: CCSUS (Kraft In/White Out)

Description: Pizza Box Plain White

Size: 10" x 10" x 1.5"

Case Pack: 100/case

Dim: 24.8" x 13.1" x 2.3" – Wgt: 14.11 lbs.

Cube: 0.43 – TI/Hi: 04/19

UPC: 842644072674



LOCK CORNER PIZZA BOXES



12" Pizza Box White Plain

344862415 – Stock

Material: CCSUS (Kraft In/White Out)

Description: Pizza Box Plain White

Size: 12" x 12" x 1.5"

Case Pack: 100/case

Dim: 28.7" x 15.1" x 2.3" – Wgt: 19.29 lbs.

Cube: 0.58 – TI/Hi: 03/19

UPC: 842644072681



14" Pizza Box White Plain

348124827 – Stock

Material: CCSUS (Kraft In/White Out)

Description: Pizza Box Plain White

Size: 14" x 14" x 1.5"

Case Pack: 100/case

Dim: 32.6" x 17.1" x 2.3" – Wgt: 25.02 lbs.

Cube: 0.74 – TI/Hi: 02/19

UPC: 842644072698



16" Pizza Box White Plain

349957874 – Stock

Material: CCSUS (Kraft In/White Out)

Description: Pizza Box Plain White

Size: 16" x 16" x 1.5"

Case Pack: 100/case

Dim: 37.0" x 19.2" x 2.5" – Wgt: 34.83 lbs.

Cube: 1.03 – TI/Hi: 02/17

UPC: 842644072704



7" MULTIPURPOSE CARTON



7" Multipurpose Carton

013414769 – Stock

♦ **CUSTOM PRINT PROGRAM MIN: 30,000 pcs.**

Material: SUS Kraft Out, White In, PP Window

Description: Hooded 6 Corner

Size: 7.0625" x 7.0625" x 1.8125"

Case Pack: 300/case

Dim: 23.1" x 15.1" x 9.6" – Wgt: 27.80 lbs.

Cube: 1.94 – TI/Hi: 05/04

UPC: 842644070960



SINGLE SLICE PIZZA CARTON



Single Slice Pizza Carton

196012361 – Stock

♦ **CUSTOM PRINT PROGRAM MIN: 45,200 pcs.**

Material: SUS Kraft Out, White In, PP Window

Description: Single Slice Carton

Size: 9.5" x 8.05" x 1.625"

Case Pack: 400/case

Dim: 26" x 13.8" x 18" – Wgt: 25.0 lbs.

Cube: 3.74 – TI/Hi: 04/02

UPC: 842644051938





- ◆ Applications include basket liners, food prep wrap, RTE (Ready To Eat) foods like donuts, bagels, muffins, cookies, candies, pretzels, hamburgers, hot dogs, and sandwiches, or as scale sheets
- ◆ Great non-stick solution for all foods
- ◆ Grease proof, waterproof, and non-absorbent
- ◆ Interleaved pop-up sheets for easy use
- ◆ Microwavable and freezable

 Hot Food Friendly

 Cold Food Friendly

 Microwavable

 Recyclable Item*
* If clean and dry
Box only



- ◆ The perfect solution for all carry out, delivery, grocery, c-store, and retail applications
- ◆ All bags and handles made from high-quality, 100% recycled kraft paper with a minimum post-consumer content of 60%
- ◆ These durable Twist and Flat Handle bags have reinforced handles virtually eliminate the need for double bagging
- ◆ Flat Handle bag handles are inside and folded down out of sight, streamlining the look of the bag
- ◆ Choose from 10 sizes of stock Twist Handle Paper Bags to suit any need
- ◆ Two sizes of Flat Handle Bags are available, 1/6 and 1/7 barrel
- ◆ **CUSTOM PRINT PROGRAM:** Customize eligible items with your brand and design (up to 8 colors)
- ◆ Custom print runs with 12 week lead time from receipt of approved artwork

Hot Food Friendly
 Renewable Materials

Cold Food Friendly

Custom Printing

Recyclable Item*
**If clean and dry*

TWIST HANDLE PAPER BAGS



8.1" x 4.5" x 10.6" Twist Handle Paper Bag
296282130 – Stock

♦ **CUSTOM PRINT PROGRAM MIN: 50,000 pcs.**

Material: 61lb. Recycled Brown Paper
Description: Serrated Top with Twist Handle
Size: 8.1" x 4.5" x 10.6"
Case Pack: 250/case
Dim: 17.7" x 16.2" x 9.2" – Wgt: 19 lbs.
Cube: 1.53 – TI/Hi: 06/05

UPC: 842644074296



10.2" x 5.1" x 12.8" Twist Handle Paper Bag
299993572 – Stock

♦ **CUSTOM PRINT PROGRAM MIN: 50,000 pcs.**

Material: 61lb. Recycled Brown Paper
Description: Serrated Top with Twist Handle
Size: 10.2" x 5.1" x 12.8"
Case Pack: 250/case
Dim: 18" x 11.3" x 15.7" – Wgt: 24 lbs.
Cube: 1.85 – TI/Hi: 09/03

UPC: 842644074302



10.2" x 6.5" x 12" Twist Handle Paper Bag
297745092 – Stock

♦ **CUSTOM PRINT PROGRAM MIN: 50,000 pcs.**

Material: 61lb. Recycled Brown Paper
Description: Serrated Top with Twist Handle
Size: 10.2" x 6.5" x 12"
Case Pack: 250/case
Dim: 17.3" x 11" x 18" – Wgt: 26 lbs.
Cube: 1.98 – TI/Hi: 08/02

UPC: 842644073831



TWIST HANDLE PAPER BAGS



13.2" x 6.9" x 13" Twist Handle Paper Bag
290015318 – Stock

♦ **CUSTOM PRINT PROGRAM MIN: 50,000 pcs.**

Material: 61lb. Recycled Brown Paper
Description: Serrated Top with Twist Handle
Size: 13.2" x 6.9" x 13"
Case Pack: 250/case
Dim: 18.1" x 14" x 15.4" – Wgt: 32.6 lbs.
Cube: 2.26 – TI/Hi: 06/03

UPC: 842644074357



13.2" x 6.9" x 16.7" Twist Handle Paper Bag
299902245 – Stock

♦ **CUSTOM PRINT PROGRAM MIN: 50,000 pcs.**

Material: 61lb. Recycled Brown Paper
Description: Serrated Top with Twist Handle
Size: 13.2" x 6.9" x 16.7"
Case Pack: 250/case
Dim: 22" x 14" x 15.4" – Wgt: 40 lbs.
Cube: 2.74 – TI/Hi: 05/03

UPC: 842644074326



13" x 5.9" x 15.7" Twist Handle Paper Bag
290612145 – Stock

♦ **CUSTOM PRINT PROGRAM MIN: 50,000 pcs.**

Material: 61lb. Recycled Brown Paper
Description: Serrated Top with Twist Handle
Size: 13" x 5.9" x 15.7"
Case Pack: 250/case
Dim: 24" x 14" x 17" – Wgt: 36 lbs.
Cube: 3.31 – TI/Hi: 06/03

UPC: 842644074319



TWIST HANDLE PAPER BAGS



13" x 9.1" x 15.7" Twist Handle Paper Bag
294925413 – Stock

♦ **CUSTOM PRINT PROGRAM MIN: 50,000 pcs.**

Material: 74lb. Recycled Brown Paper
 Description: Serrated Top with Twist Handle
 Size: 13" x 9.1" x 15.7"
 Case Pack: 200/case
 Dim: 20.8" x 14" x 15.4 – Wgt: 40 lbs.
 Cube: 2.6 – TI/Hi: 05/03
 UPC: 842644074333



14" x 7.9" x 14.6" Twist Handle Paper Bag
299074474 – Stock

♦ **CUSTOM PRINT PROGRAM MIN: 50,000 pcs.**

Material: 74lb. Recycled Brown Paper
 Description: Serrated Top with Twist Handle
 Size: 14" x 7.9" x 14.6"
 Case Pack: 200/case
 Dim: 19.6" x 15" x 15.4 – Wgt: 37.5 lbs.
 Cube: 2.62 – TI/Hi: 06/03
 UPC: 842644074364



14" x 9.6" x 16.5" Twist Handle Paper Bag
295140218 – Stock

♦ **CUSTOM PRINT PROGRAM MIN: 50,000 pcs.**

Material: 68lb. Recycled Brown Paper
 Description: Serrated Top with Twist Handle
 Size: 14" x 9.6" x 16.5"
 Case Pack: 200/case
 Dim: 21.8" x 15" x 14.2" – Wgt: 41.8 lbs.
 Cube: 2.69 – TI/Hi: 05/03
 UPC: 842644073824



TWIST HANDLE PAPER BAGS



15.9" x 5.9" x 12" Twist Handle Paper Bag
298559078 – Stock

♦ **CUSTOM PRINT PROGRAM MIN: 50,000 pcs.**

Material: 61lb. Recycled Brown Paper
 Description: Serrated Top with Twist Handle
 Size: 15.9" x 5.9" x 12"
 Case Pack: 250/case
 Dim: 17.5" x 17.3" x 15" – Wgt: 34 lbs.
 Cube: 2.63 – TI/Hi: 04/03
 UPC: 842644074340



HANDLE CUFFS™

PACKAGING THAT SEALS THE MEAL.

Don't trust staples or stickers to protect delivery and carry out orders. That's a job for Handle Cuffs! A tamper-evident system designed to work with most paper bags, Handle Cuffs makes it easy to integrate tamper evidence into any delivery process.

AVAILABLE IN THREE SIZES FOR USE WITH MULTIPLE SIZES OF PAPER BAGS.

16" Handle Cuffs
017633936 – Stock

13" Handle Cuffs
016636672 – Stock

10" Handle Cuffs
019349200 – Stock

- ♦ Handle Cuffs is designed to protect the bag top and gussets from tampering*
- ♦ Printed area for order information
- ♦ Right-sized opening for bag handles allows room for handles but not for hands
- ♦ Mailer style pull strip makes opening easy
- ♦ Vertical perforations at varied bag widths tear to release gussets when opening

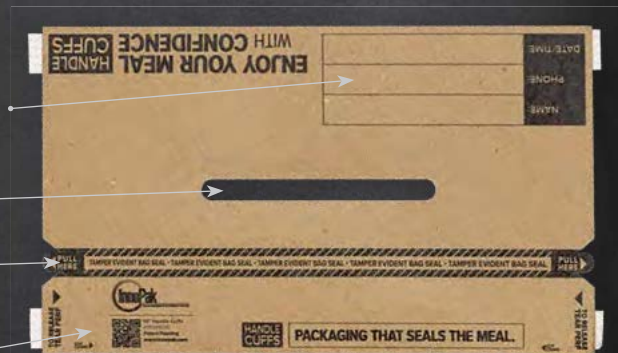

* Patent Pending

Did you know that **28%** of delivery drivers admit to taking food from a delivery order, and **54%** of delivery drivers admit to having the urge to take food from a delivery order. — US Foods Study, May 9 - 13, 2019

FLAT HANDLE PAPER BAGS



1/7 Barrel Flat Handle Paper Bag

295338625 – Stock

♦ **CUSTOM PRINT PROGRAM MIN: 50,000 pcs.**

Material: 74lb. Recycled Brown Paper

Description: Serrated Top with Flat Handle

Size: 12" x 7" x 14"

Case Pack: 250/case

Dim: 15" x 13" x 20.2" – Wgt: 38.4 lbs.

Cube: 2.28 – TI/HL: 09/02

UPC: 842644075088



1/6 Barrel Flat Handle Paper Bag

292429432 – Stock

♦ **CUSTOM PRINT PROGRAM MIN: 50,000 pcs.**

Material: 74lb. Recycled Brown Paper

Description: Serrated Top with Flat Handle

Size: 12" x 7" x 17"

Case Pack: 250/case

Dim: 17.7" x 12.8" x 18.9" – Wgt: 41.89 lbs.

Cube: 2.48 – TI/HL: 08/02

UPC: 842644075071



ENHANCE YOUR BRAND!

CUSTOM PRINTED HANDLED PAPER CARRY OUT BAGS



Custom branding is an easy way to raise awareness and elevate your brand. Whether you provide a design or let our talented team create one for you, custom branding can help take your business to the next level.

- ♦ Custom print of out stock sizes of bags
- ♦ Print all surfaces of the bag
- ♦ High-quality printing
- ♦ Print up to 8-colors



A SUPERIOR QUALITY FLAT HANDLE BAG DESIGN

INNO-PAK'S BAGS ARE DESIGNED TO MAKE DOUBLE BAGGING A THING OF THE PAST!

Designed for optimum strength and durability, Inno-Pak's Flat Handle Bags eliminate the need to double bag. The comfortable 1/2" handles are glued inside the bag and reinforced with a full-length patch across the handle base providing superior strength. The handles fold down inside the bags giving them a clean, sleek look compared to the competition.

- ♦ Available in two popular sizes, 1/6 and 1/7 Barrel
- ♦ All bags are cased and not bundled, preventing damage in shipping
- ♦ The easy to hold 1/2" handles provide strength and comfort
- ♦ Additional glued patches reinforce the handles providing added strength
- ♦ The inside handle provides a streamlined, elegant look to the bag
- ♦ Handles are glued and folded down inside the bag, out of sight

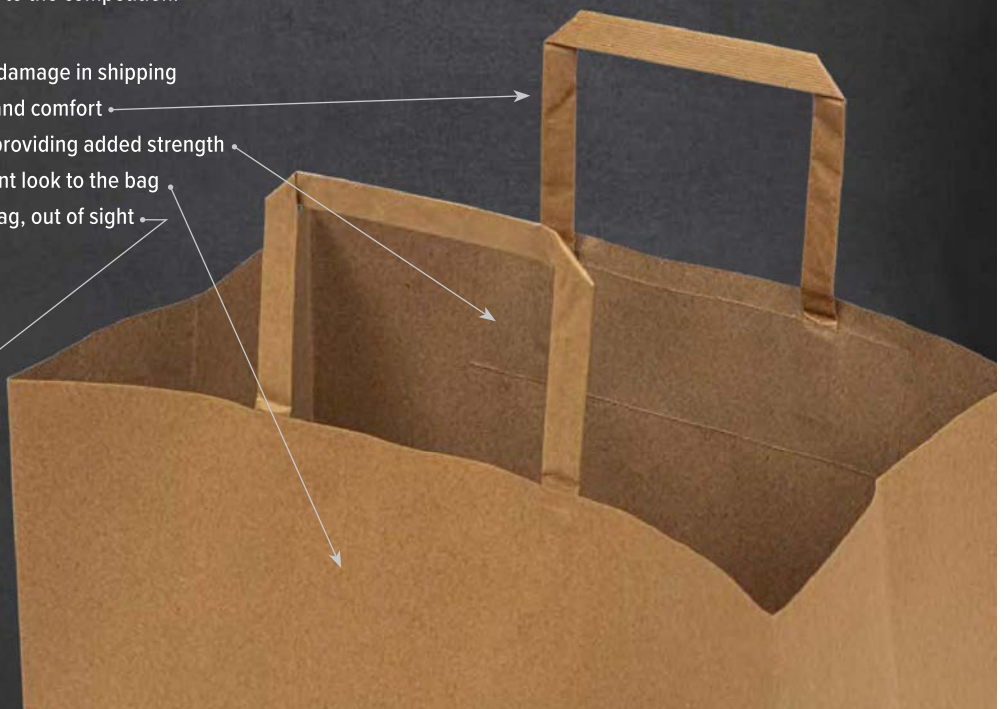



- ◆ Protect your carryout and delivery orders from tampering with the Handle Cuffs* Tamper-Evident Bag Seals (**Patent Pending*)
- ◆ Designed to work with most twist handle paper bags making it easy to integrate Handle Cuffs into a delivery process
- ◆ Handle Cuffs Advantage: Staples can be pulled and restapled or fall into food, and stickers don't fully secure the bag top or gusset
- ◆ Designed to overhang the edges of the bag to protect tampering with the side gusset
- ◆ Convenient mailer style pull strip and vertical perforations at varied bag widths for easy opening upon pick-up or delivery
- ◆ Three sizes: 16" Handle Cuffs (12, 13, & 14" face bags), 13" Handle Cuffs (10 & 11" face bags), 10" Handle Cuffs (8" face bags)
- ◆ **CUSTOM PRINT PROGRAM:** Customize eligible items with your brand and design (up to 4 colors)
- ◆ Low minimum custom print runs with 12 week lead time from receipt of approved artwork

 Tamper Evident

 Custom Printing

 Renewable Materials

 Recyclable Item*
**If clean and dry*

PROTECT & SERVE WITH HANDLE CUFFS™

PACKAGING THAT SEALS THE MEAL.

Don't trust staples or stickers to protect delivery and carryout orders. That's a job for Handle Cuffs!

- ◆ Handle Cuffs is designed to protect the bag top and gussets from tampering*
- ◆ Printed area for order information
- ◆ Right-sized opening for bag handles allows room for handles but not for hands
- ◆ Mailer style pull strip makes opening easy
- ◆ Vertical perforations at varied bag widths tear to release gussets when opening

* Patent Pending



28% of delivery drivers admit to taking food from a delivery order, and **54%** of delivery drivers admit to having the urge to take food from a delivery order. — US Foods Study, May 9 - 13, 2019

HANDLE CUFFS



16" Handle Cuffs

017633936 – Stock

◆ **CUSTOM PRINT PROGRAM MIN: 50,000 pcs.**

Material: Kraft

Description: Fits 12", 13", & 14" Bags

Size: 16" x 6"

Case Pack: 250/case

Dim: 16.81" x 6.56" x 6.63" – Wgt: 9.8 lbs.

Cube: 2.21 – TI/Hi: 16/07

UPC: 842644073664



13" Handle Cuffs

016636672 – Stock

◆ **CUSTOM PRINT PROGRAM MIN: 50,000 pcs.**

Material: Kraft

Description: Fits 10" & 11" Bags

Size: 13" x 6"

Case Pack: 250/case

Dim: 13.81" x 6.56" x 6.63" – Wgt: 8.12 lbs.

Cube: 1.79 – TI/Hi: 20/07

UPC: 842644073671



10" Handle Cuffs

019349200 – Stock

◆ **CUSTOM PRINT PROGRAM MIN: 50,000 pcs.**

Material: Kraft

Description: Fits 8" Bags

Size: 10" x 6"

Case Pack: 250/case

Dim: 10.81" x 6.56" x 6.63" – Wgt: 6.57 lbs.

Cube: 1.38 – TI/Hi: 24/07

UPC: 842644073725



HANDLE CUFFS APPLICATION & USE INSTRUCTIONS



1. Apply Handle Cuffs to Bag

- ◆ Placing Handle Cuff over both handles and center
- ◆ Remove tape strips



2. Seal Handle Cuffs to Bag

- ◆ Press Handle Cuff to bag
- ◆ Press overlap together to seal the bag gusset





3. Unlock the Handle Cuffs

- ◆ Tear pull strip to unlock
- ◆ Tear vertical perfs along the bag sides to unlock the gusset



- ◆ Multiple bag sizes, styles, and handle configurations available
- ◆ Stock T-shirt bags are available in Pinch Bottom and Square Bottom styles
- ◆ Plain and printed bag options
- ◆ Large capacity bags available
- ◆ **CUSTOM PRINT PROGRAM:** Customize eligible items with your brand and design (up to 8 colors)
- ◆ Low minimum custom print runs with 12 week lead time from receipt of approved artwork

 Hot Food Friendly
 Cold Food Friendly

 Leak Resistant

 Custom Printing

 Recyclable Item*
* If clean and dry
Recyclability varies by item type
Check with your local municipality/store

RIGID HANDLED SHOPPERS



14" x 10" x 15" x 10" Rigid Handled Shopper - Fresh Flavor™
264867156 – Stock

♦ **CUSTOM PRINT PROGRAM MIN: 25,000 pcs.**

Material: White Smooth PPPE
Description: Flat Bottom, Insert, 1CF/1CB
Size: 14" x 10" x 15" x 10"
Case Pack: 100/case
Dim.: 17.7" x 15.5" x 7.2" – Wgt: 19.18 lbs.
Cube: 1.14 – TI/Hi: 06/06
UPC: 842644065171



19" x 10" x 12" x 10" Rigid Handle Shopper - Plain White
507100100 – Stock

♦ **CUSTOM PRINT PROGRAM MIN: 25,000 pcs.**

Material: White Smooth PPPE
Description: Flat Bottom, Insert
Size: 19" x 10" x 12" x 10"
Case Pack: 200/case
Dim.: 20" x 19" x 12.7" – Wgt: 48.2 lbs.
Cube: 2.79 – TI/Hi: 04/03
UPC: 838702008945



22" x 14" x 15" x 14" Rigid Handled Shopper - Fresh Flavor™
266241106 – Stock

♦ **CUSTOM PRINT PROGRAM MIN: 25,000 pcs.**

Material: White Smooth PPPE
Description: Flat Bottom, Insert, 1CF/1CB
Size: 22" x 14" x 15" x 14"
Case Pack: 50/case
Dim.: 23" x 18.1" x 5" – Wgt: 20 lbs.
Cube: 1.20 – TI/Hi: 04/09
UPC: 842644065164



RIGID HANDLE SHOPPERS



22" x 14" x 15" x 14" Rigid Handle Shopper - Plain White
503795093 – Stock

♦ **CUSTOM PRINT PROGRAM MIN: 25,000 pcs.**

Material: White Smooth PPPE
Description: Flat Bottom, Insert
Size: 23" x 14" x 15" x 14"
Case Pack: 50/case
Dim.: 23" x 18.1" x 4.9" – Wgt: 20 lbs.
Cube: 1.18 – TI/Hi: 04/09
UPC: 842644020194



6.75" x 4.75" x 8.5" x 4.75" Soft Loop Handled Shopper - Clear
527382644 – Stock

♦ **CUSTOM PRINT PROGRAM MIN: 100,000 pcs.**

Material: Clear Superprope PP/PE/PP
Description: Flat Bottom, Insert
Size: 6.75" x 4.75" x 8.5" x 4.75"
Case Pack: 200/case
Dim.: 13.4" x 9" x 6.6" – Wgt: 8.2 lbs.
Cube: 0.46 – TI/Hi: 15/07
UPC: 842644009854



12" x 9" x 17" x 9" Soft Loop Handled Shopper - Plain White
264310320 – Stock

♦ **CUSTOM PRINT PROGRAM MIN: 25,000 pcs.**

Material: Natural Smooth HDPE
Description: Flat Bottom, INPK Brand
Size: 12" x 9" x 17" x 9"
Case Pack: 250/case
Dim.: 21.7" x 13" x 5.3" – Wgt: 17 lbs.
Cube: 0.87 – TI/Hi: 06/08
UPC: 842644051921



PINCH BOTTOM T-SHIRT BAGS



11.5" x 6.5" x 21" T-shirt Bag - Thank You
262049856 – Stock

♦ **CUSTOM PRINT PROGRAM MIN: 25,000 pcs.**

Material: White Smooth HDPE
Description: T-shirt Bag Style, 1CF/OCB
Size: 11.5" x 6.5" x 21"
Case Pack: 1,000/case
Dim: 13" x 12" x 5.5" – Wgt: 11.2 lbs.
Cube: 0.50 – TI/Hi: 12/07
UPC: 842644031305



11.5" x 6.5" x 21" T-shirt Bag - Plain White
267245878 – Stock

♦ **CUSTOM PRINT PROGRAM MIN: 25,000 pcs.**

Material: White Smooth HDPE
Description: T-shirt Bag Style
Size: 11.5" x 6.5" x 21"
Case Pack: 1,000/case
Dim: 13" x 12" x 5.5" – Wgt: 11.2 lbs.
Cube: 0.50 – TI/Hi: 12/07
UPC: 842644044831



12" x 8" x 25" T-shirt Bag - Plain White
346793766 – Stock

♦ **CUSTOM PRINT PROGRAM MIN: 25,000 pcs.**

Material: White Smooth HDPE
Description: T-shirt Bag Style
Size: 12" x 8" x 25"
Case Pack: 1,000/case
Dim: 13.8" x 12.3" x 6.4" – Wgt: 19.35 lbs.
Cube: 0.36 – TI/Hi: 12/06
UPC: 842644073954



SQUARE BOTTOM T-SHIRT BAGS



11.5" x 10.5" x 20" x 10.5" HD
Square Bottom T-shirt Bag - Fresh Flavor™
268106256 – Stock

♦ **CUSTOM PRINT PROGRAM MIN: 50,000 pcs.**

Material: White Smooth HDPE
Description: T-Shirt Bag Style, 1CF/1CB
Size: 11.5" x 10.5" x 20" x 10.5"
Case Pack: 250/case
Dim.: 12.5" x 11.7" x 5.6" – Wgt: 8.6 lbs.
Cube: 0.47 – TI/Hi: 12/08
UPC: 842644065188



11.5" x 10.5" x 20" x 10.5" HD
Square Bottom T-shirt Bag - Plain White
503713222 – Stock

♦ **CUSTOM PRINT PROGRAM MIN: 50,000 pcs.**

Material: White Smooth HDPE
Description: T-Shirt Bag Style
Size: 11.5" x 10.5" x 20" x 10.5"
Case Pack: 250/case
Dim.: 12.4" x 11.7" x 5.7" – Wgt: 8.6 lbs.
Cube: 0.48 – TI/Hi: 12/08
UPC: 842644026417



BAG RACK



T-shirt Bag Rack
297271063 – Stock

Material: Metal
Description: T-Shirt Bag Style
Size: Standard
Case Pack: 2/case
Dim.: 15.4" x 15.2" x 15.5" – Wgt: 9.6 lbs.
Cube: 2.10 – TI/Hi: 06/03
UPC: 842644026059

WAVE TOP BAGS



23.5" x 20" + 10" Wave Top Bag - Plain White 343944901 – Stock

♦ **CUSTOM PRINT PROGRAM MIN: 25,000 pcs.**

Material: White Smooth HDPE

Description: Wave Top Bag Style

Size: 23.5" x 20" + 10"

Case Pack: 250/case

Dim: 12.3" x 11.5" x 5" – Wgt: 10.8 lbs.

Cube: 0.41 – TI/Hi: 12/06

UPC: 842644073961



GALLONPAK DRINK DISPENSER



GallonPak Drink Dispenser 294601555 – Stock

♦ **CUSTOM PRINT PROGRAM MIN: 15,000 pcs.**

Capacity: 128 Fluid oz.

Material: Clear PET/NY/PE

Description: Gallon Beverage Pouch

Size: 12" x 12.8" x 5.7"

Case Pack: 25/case

Dim: 19.7" x 14.1" x 4" – Wgt: 4 lbs.

Cube: 0.64 – TI/Hi: 06/11

UPC: 842644052416



CATERING BAGS



18" x 7" x 24.5" Party Tray Bag - Clear 343700100 – Stock

♦ **CUSTOM PRINT PROGRAM MIN: 25,000 pcs.**

Material: Clear Smooth LDPE

Description: Dual Side Gusset, Die Cut Handle

Size: 18" x 7" x 24.5"

Case Pack: 50/case

Dim: 18.9" x 13.2" x 2" – Wgt: 4.6 lbs.

Cube: 0.29 – TI/Hi: 07/23

UPC: 842644006297



CUSTOM BAG SIZES & BRANDING AVAILABLE!

DON'T SEE THE RIGHT SIZE OR STYLE BAG FOR YOUR NEEDS?

We can produce a custom bag tailored to your specific needs or application. Choose from three styles of T-shirt bags (Pinch Bottom, Angle Seal, and Square Bottom), Wave Top Bags, Die Cut Handle Bags and Rigid Handle Bags.

DO YOU NEED A CUSTOM BRANDED A BAG?

We can do that too! Add your logo or branding to any of our bag options to elevate your brand.

- ♦ **CUSTOM PRINT PROGRAM:** Customize eligible items with your brand and design (up to 8 colors)
- ♦ Low minimum custom print runs with 12 week lead time from receipt of approved artwork
- ♦ Made in the U.S.A option available (up to 4 colors)





Call your Inno-Pak sales representative for more information or to place an order.



- ◆ Choose from zipper, slide, and flip-top deli bag options
- ◆ Header and saddle styles for ease of use
- ◆ Plain and printed Deli Fresh or Fresh Flavor™ options
- ◆ Cost-effective HDPE Slide Deli Fresh bags are an alternative to standard
- ◆ **CUSTOM PRINT PROGRAM:** Customize eligible items with your brand and design (up to 10 colors)
- ◆ Low minimum custom print runs with 12 week lead time from receipt of approved artwork

 Hot Food Friendly
 Cold Food Friendly

 Leak Resistant

 Custom Printing

 Recyclable Item*
** If clean and dry
 Recyclability varies by item type
 Check with your local municipality/store*

RESEALABLE DELI BAGS



10" x 8" HD
Slide Up Deli Bag - Deli Fresh
309859182 – Stock
♦ **CUSTOM PRINT MIN: 72,000 pcs.**
Material: Clear HDPE
Description: Top Load Header Style
Size: 10" x 8"
Case Pack: 1,000/case
Dim: 14.6" x 11" x 8.7" – Wgt: 5.67 lbs.
Cube: 0.81 – TI/Hi: 11/05
UPC: 842644061876



10.75" x 8" LD
Slide Zipper Bag - Plain
239822250 – Stock
Material: Clear Smooth LDPE
Description: Bottom Load, Header Style
Size: 10.75" x 8"
Case Pack: 1,000/case
Dim: 15.7" x 11.7" x 9.6" – Wgt: 15.2 lbs.
Cube: 1.02 – TI/Hi: 10/05
UPC: 842644020460



10" x 8" LD
Slide Up Deli Bag - Deli Express
304253090 – Stock
♦ **CUSTOM PRINT MIN: 72,000 pcs.**
Material: High Clarity LDPE
Description: Top Load, Header Style
Size: 10" x 8"
Case Pack: 1,000/case
Dim: 14.6" x 11.1" x 9" – Wgt: 12 lbs.
Cube: 0.84 – TI/Hi: 11/05
UPC: 842644017897



10" x 8" LD
Zipper Bag - Deli Express
305226489 – Stock
♦ **CUSTOM PRINT MIN: 72,000 pcs.**
Material: High Clarity LDPE
Description: Top Load, Saddle Style
Size: 10" x 8"
Case Pack: 1,000/case
Dim: 10.2" x 8.1" x 10.6" – Wgt: 10 lbs.
Cube: 0.51 – TI/Hi: 24/04
UPC: 842644017880

RESEALABLE DELI BAGS



10" x 8" LD
Zip Bag - Fresh Flavor™
302926543 – Stock
♦ **CUSTOM PRINT MIN: 72,000 pcs.**
Material: High Clarity LDPE
Description: Top Load, Saddle Style
Size: 10" x 8"
Case Pack: 1,000/case
Dim.: 10.2" x 8.2" x 10.7" – Wgt: 9.6 lbs.
Cube: 0.52 – TI/Hi: 24/04
UPC: 842644063535



10.75" x 8" LD
Slide Bag - Fresh Flavor™
302000203 – Stock
♦ **CUSTOM PRINT MIN: 72,000 pcs.**
Material: High Clarity LDPE
Description: Bottom Load, Header Style
Size: 10.75" x 8"
Case Pack: 1,000/case
Dim.: 15.5" x 11.6" x 9.5" – Wgt: 14.6 lbs.
Cube: 0.99 – TI/Hi: 10/04
UPC: 842644063542



10.75" x 8" LD
Slide Bag - Fresh Flavor™
344594912 – Stock
♦ **CUSTOM PRINT MIN: 72,000 pcs.**
Material: High Clarity LDPE
Description: Top Load, Header Style
Size: 10.75" x 8"
Case Pack: 1,000/case
Dim.: 15.7" x 11.5" x 9.5" – Wgt: 13.4 lbs.
Cube: 0.99 – TI/Hi: 10/04
UPC: 842644066888



8.5" x 8.5" HD
Flip-Top Bag - Fresh Flavor™
234000204 – Stock
♦ **CUSTOM PRINT MIN: 100,000 pcs.**
Material: Clear Embossed HDPE
Description: Flip Top, Saddle Pack
Size: 8.5" x 8.5"
Case Pack: 2,000/case
Dim.: 11.1" x 10" x 3.1" – Wgt: 5.2 lbs.
Cube: 0.20 – TI/Hi: 15/15
UPC: 842644063658

FLIP-TOP DELI BAGS



10.5" x 9.5" HD
Flip-Top Bag - Fresh Flavor™
343023409 – Stock
♦ **CUSTOM PRINT MIN: 100,000 pcs.**
Material: Clear Embossed HDPE
Description: Flip Top, Saddle Pack
Size: 10.5" x 9.5"
Case Pack: 2,000/case
Dim.: 12.2" x 11.5" x 3" – Wgt: 7.93 lbs.
Cube: 0.24 – TI/Hi: 12/15
UPC: 842644064099



6" x 4" x 14" HD
Bag - Fresh Flavor™
211200204 – Stock
♦ **CUSTOM PRINT MIN: 50,000 pcs.**
Material: White Smooth HDPE
Description: Loose Pack
Size: 6" x 4" x 14"
Case Pack: 1,000/case
Dim.: 12.6" x 8" x 4.3" – Wgt: 8 lbs.
Cube: 0.25 – TI/Hi: 18/10
UPC: 842644063962



7" x 3" x 11" + 1" HD
Bag - Fresh Flavor™
212100203 – Stock
♦ **CUSTOM PRINT MIN: 50,000 pcs.**
Material: White Smooth HDPE
Description: Standard Header Style 5
Size: 7" x 3" x 11" + 1"
Case Pack: 1,000/case
Dim.: 12.7" x 8" x 4.5" – Wgt: 6.6 lbs.
Cube: 0.26 – TI/Hi: 19/10
UPC: 842644063986



7" x 4" x 14" + 1" HD
Bag - Fresh Flavor™
212400203 – Stock
♦ **CUSTOM PRINT MIN: 50,000 pcs.**
Material: White Smooth HDPE
Description: Standard Header Style 5
Size: 7" x 4" x 14" + 1"
Case Pack: 1,000/case
Dim.: 15.7" x 7.9" x 4.1" – Wgt: 10.2 lbs.
Cube: 0.29 – TI/Hi: 15/11
UPC: 842644064006



SEAFOOD CARRYOUT BAGS

- ◆ Designed for ease of use
- ◆ HDPE bags on headers for easy dispensing
- ◆ **CUSTOM PRINT PROGRAM:** Customize eligible items with your brand and design (up to 10 colors)
- ◆ Custom print runs with 12 week lead time from receipt of approved artwork

Hot Food Friendly

Leak Resistant

Cold Food Friendly

SEAFOOD MERCHANDISING BAGS

- ◆ High clarity film
- ◆ Engineered for strength and freezer protection
- ◆ **CUSTOM PRINT PROGRAM:** Customize eligible items with your brand and design (up to 10 colors)
- ◆ Custom print runs with 12 week lead time from receipt of approved artwork

Custom Printing

Recyclable Item*

* If clean and dry
Recyclability varies by item type
Check with your local municipality/store

SEAFOOD CARRYOUT BAGS



Seafood Bag

264877875 – Stock

♦ **CUSTOM PRINT PROGRAM MIN: 50,000 pcs.**

Material: White HDPE

Description: Die Cut Handle Bag

Size: 17" x 17"

Case Pack: 500/case

Dim: 18.5" x 11.3" x 5.5" – Wgt: 20 lbs.

Cube: 0.67 – TI/Hi: 04/12

UPC: 842644074524



Seafood Bag - Today's Catch

223300700 – Stock

♦ **CUSTOM PRINT PROGRAM MIN: 25,000 pcs.**

Material: Clear Embossed HDPE

Description: Standard Header 3, 2CF

Size: 7" x 4" x 13.5" + 1"

Case Pack: 1,000/case

Dim: 15.7" x 7.9" x 4.1" – Wgt: 9.04 lbs.

Cube: 0.29 – TI/Hi: 15/11

UPC: 838702003889



HD Seafood Bag - Delicious

222400800 – Stock

♦ **CUSTOM PRINT PROGRAM MIN: 25,000 pcs.**

Material: Clear Embossed HDPE

Description: Standard Header 5, 1CF

Size: 7" x 4" x 14" + 1"

Case Pack: 1,000/case

Dim: 15.7" x 8.1" x 4.7" – Wgt: 9.8 lbs.

Cube: 0.35 – TI/Hi: 15/10

UPC: 838702003872



SEAFOOD CARRYOUT BAGS



HD Seafood Bag - Delicious

223500800 – Stock

♦ **CUSTOM PRINT PROGRAM MIN: 25,000 pcs.**

Material: Clear Embossed HDPE

Description: Standard Header 3, 2CF

Size: 7.5" x 5" x 14" + 1"

Case Pack: 1,000/case

Dim: 15.9" x 8.3" x 4.7" – Wgt: 11.02 lbs.

Cube: 0.36 – TI/Hi: 14/10

UPC: 838702003902



Lobster Bag

♦ **CUSTOM PRINT PROGRAM MIN: 100,000 pcs.**

503000901 – Stock

Material: White Smooth PP

Description: Flat Bottom, Handle, 2CF/2CB

Size: 9.75" x 6" x 17" x 6"

Case Pack: 100/case

Dim: 10.6" x 9.1" x 5.5" – Wgt: 6.2 lbs.

Cube: 0.32 – TI/Hi: 20/08

UPC: 838702002264



SEAFOOD MERCHANDISING BAGS



Bulk Food Bag

326981000 – Stock

♦ **CUSTOM PRINT PROGRAM MIN: 25,000 pcs.**

Material: Clear Smooth LDPE

Description: Dispenser Pack, 1CF

Size: 5.25" x 3.25" x 10"

Case Pack: 2,000/case (4 packs of 500)

Dim: 12.6" x 11.6" x 7.7" – Wgt: 11.33 lbs.

Cube: 0.65 – TI/Hi: 12/06

UPC: 838702007429



BAG RACKS



3" Header Bag Rack

296663796 – Stock

Material: Aluminum

Description: Header Style 3, Black

Size: 3"

Case Pack: 1/case

UPC: 842644025946



5" Header Bag Rack

290367240 – Stock

Material: Aluminum

Description: Header Style 5, Black

Size: 5"

Case Pack: 1/case

UPC: 842644025939



T Bar Rack

290522864 – Stock

Material: Aluminum w/Plastic Hook

Description: T Bar Rack, White

Size: Small

Case Pack: 1/case

UPC: 842644025953



- ◆ Made from crystal clear film
- ◆ Engineered for strength and freezer protection
- ◆ Available with tape closure strip seal
- ◆ **CUSTOM PRINT PROGRAM:** Customize eligible items with your brand and design (up to 10 colors)
- ◆ Custom print runs with 12 week lead time from receipt of approved artwork

 Cold Food Friendly

 Custom Printing

TAPE CLOSURE SUB & SANDWICH BAGS

5.25" x 7.25" + 1" Lip PP Food Bag

407400103 – Stock

◆ CUSTOM PRINT PROGRAM MIN: 100,000 pcs.

Material: Superprope

Description: Loose Pack, Seal Strip

Size: 5.25" x 7.25" + 1"

Case Pack: 1,000/case

Dim: 9.1" x 5.5" x 3" – Wgt: 3.26 lbs.

Cube: 0.09 – TI/HI: 34/12

UPC: 838702004718



6" x 7" + 3" Lip PP Food Bag

429443709 – Stock

◆ CUSTOM PRINT PROGRAM MIN: 100,000 pcs.

Material: Superprope

Description: Loose Pack, Seal Strip

Size: 6" x 7" + 3"

Case Pack: 1,000/case

Dim: 10.8" x 7" x 3.1" – Wgt: 5.4 lbs.

Cube: 0.14 – TI/HI: 19/14

UPC: 842644021153



6.5" x 6.5" + 0" + 3" Lip PP Food Bag

409518181 – Stock

◆ CUSTOM PRINT PROGRAM MIN: 100,000 pcs.

Material: Superprope

Description: Loose Pack, Seal Strip

Size: 6.5" x 6.5" + 0" + 3"

Case Pack: 1,000/case

Dim: 10" x 7.2" x 2.7" – Wgt: 4.19 lbs.

Cube: 0.11 – TI/HI: 23/15

UPC: 842644021177



TAPE CLOSURE SUB & SANDWICH BAGS

7" x 7" + 3" Lip PP Food Bag

407000104 – Stock

◆ CUSTOM PRINT PROGRAM MIN: 100,000 pcs.

Material: Superprope

Description: Loose Pack, Seal Strip

Size: 7" x 7" + 3"

Case Pack: 1,000/case

Dim: 10.7" x 8" x 3.1" – Wgt: 5.2 lbs.

Cube: 0.15 – TI/HI: 22/15

UPC: 838702004671



9" x 7" + 3" Lip PP Food Bag

407100104 – Stock

◆ CUSTOM PRINT PROGRAM MIN: 100,000 pcs.

Material: Superprope

Description: Loose Pack, Seal Strip

Size: 9" x 7" + 3"

Case Pack: 1,000/case

Dim: 10.6" x 10" x 3.2" – Wgt: 7.8 lbs.

Cube: 0.20 – TI/HI: 16/14

UPC: 838702004688



14" x 7" + 0" + 3" PP Food Bag

407200104 – Stock

◆ CUSTOM PRINT PROGRAM MIN: 100,000 pcs.

Material: Superprope

Description: Loose Pack, Seal Strip

Size: 14" x 7" + 0" + 3"

Case Pack: 1,000/case

Dim: 15" x 11.2" x 3.2" – Wgt: 11.68 lbs.

Cube: 0.31 – TI/HI: 10/14

UPC: 838702004695



SUB & SANDWICH BAGS

6" x 14.5" PP Sandwich Bag

423753404 – Stock

◆ CUSTOM PRINT PROGRAM MIN: 100,000 pcs.

Material: Superprope PP

Description: Loose Pack, Plain

Size: 6" x 14.5"

Case Pack: 500/case

Dim: 16.4" x 6.8" x 2.1" – Wgt: 5.2 lbs.

Cube: 0.14 – TI/HI: 16/22

UPC: 842644013790



8.5" x 27.75" + 0" PP Sandwich Bag

423202508 – Stock

◆ CUSTOM PRINT PROGRAM MIN: 100,000 pcs.

Material: Superprope

Description: Loose Pack, Plain

Size: 8.5" x 27.75" + 0"

Case Pack: 500/case

Dim: 15" x 9.4" x 3.9" – Wgt: 13.44 lbs.

Cube: 0.32 – TI/HI: 13/12

UPC: 842644013806



SUB & SANDWICH BAGS

15" x 15" BOPP Deli Sheets

488100103 – Stock

◆ CUSTOM PRINT PROGRAM MIN: 100,000 pcs.

Material: BOPP

Description: Loose Pack, Plain

Size: 15" x 15"

Case Pack: 3,000/case

Dim: 16" x 16.1" x 4.6" – Wgt: 25.2 lbs.

Cube: 0.69 – TI/HI: 06/10

UPC: 838702005661



INNOVATIVE IDEAS

Lined area for writing innovative ideas.



- ◆ Set up for convenience with easy loading header system and zipper closure
- ◆ Handle bags for grab and go convenience
- ◆ Made with vented, anti-fog film to keep food fresh and hot
- ◆ Warming unit and microwave safe up to 200° F
- ◆ Easy dispense racks and zipper bag quick closer tool available
- ◆ **CUSTOM PRINT PROGRAM:** Customize eligible items with your brand and design (up to 10 colors)
- ◆ Low minimum custom print runs with 12 week lead time from receipt of approved artwork

 Hot Food Friendly

 Leak Resistant

 Custom Printing

 Microwavable

 Cold Food Friendly

WHY CHOOSE ROTISSERIE BAGS OVER DOMES?

ROTISSERIE BAGS ARE EASY TO USE, EFFICIENT, AND SAVE YOU MONEY.

Save time and space by switching to Inno-Pak's Rotisserie Bags. These durable bags are warming table and microwave friendly, and take up a fraction of the space a standard dome does.

- ◆ A single truckload of Inno-Pak Rotisserie Bags is equal to over 10 truckloads of domes
- ◆ Smaller cases equals lighter cases with a much smaller storage footprint

THE NUMBERS DON'T LIE:

ROTISSERIE BAGS

- ◆ Case Pack: **250 bags**
- ◆ Cases/Pallet: **105**
- ◆ Units/Truck: **1,470,000**
- ◆ Case Cube: **0.51**
- ◆ Case Wgt: **8.4 lbs.**

DOME #1

- ◆ Case Pack: 170 pcs.
- ◆ Cases/Pallet: 24
- ◆ Units/Truck: 114,240
- ◆ Case Cube: 3.97
- ◆ Case Wgt: 20.18 lbs.

DOME #2

- ◆ Case Pack: 100 pcs.
- ◆ Cases/Pallet: 30
- ◆ Units/Truck: 84,000
- ◆ Case Cube: 3.47
- ◆ Case Wgt: 12 lbs.

DOME #3

- ◆ Case Pack: 100 pcs.
- ◆ Cases/Pallet: 30
- ◆ Units/Truck: 168,000
- ◆ Case Cube: 1.95
- ◆ Case Wgt: 13.11 lbs.

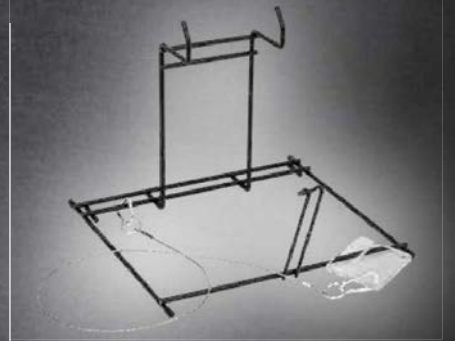

Mat Black Counter Top Rack includes Quick Closer Tool and Tether for efficiency.

297144062 – Counter Top Rack Kit with Quick Closer Tool and Tether
346950056 – Quick Closer Tool

ROTISSERIE CHICKEN BAGS



Half Rotisserie/Sections Bag 263985648 – Stock

◆ **CUSTOM PRINT PROGRAM MIN: 100,000 pcs.**

Material: Clear, Anti-fog PET/CPP

Description: Header Bag, Zipper, Vented, 2CF/2CB

Size: 11.5" x 5" + 5.5" + 1.5"

Case Pack: 250/case

Dim: 11.8" x 8.6" x 6.3" – Wgt: 6.5 lbs.

Cube: 0.37 – TI/Hi: 18/07

UPC: 842644072551



Rotisserie Chicken Bag 264204538 – Stock

◆ **CUSTOM PRINT PROGRAM MIN: 100,000 pcs.**

Material: Clear, Anti-fog PET/CPP

Description: Header Bag, Zipper, Vented, 2CF/2CB

Size: 12.75" x 6.75" + 5.5" + 1.5"

Case Pack: 250/case

Dim: 13.5" x 9.7" x 6.5" – Wgt: 8.4 lbs.

Cube: 0.49 – TI/Hi: 15/07

UPC: 842644063399



Large Rotisserie Chicken Bag 268261349 – Stock

◆ **CUSTOM PRINT PROGRAM MIN: 100,000 pcs.**

Material: Clear, Anti-fog PET/CPP

Description: Header Bag, Zipper, Vented, 2CF/2CB

Size: 13.25" x 7" + 6.5" + 1.5"

Case Pack: 250/case

Dim: 14" x 10.6" x 6.5" – Wgt: 9 lbs.

Cube: 0.56 – TI/Hi: 11/07

UPC: 842644067144



FRIED CHICKEN BAGS



4 pc. Fried Chicken Bag 262078881 – Stock

◆ **CUSTOM PRINT PROGRAM MIN: 100,000 pcs.**

Material: Clear, Anti-fog PET/CPP

Description: Header Bag, Zipper, Vented, 2CF/2CB

Size: 9" x 6.5" + 5" + 1.5"

Case Pack: 250/case

Dim: 9.8" x 9.8" x 6.7" – Wgt: 6 lbs.

Cube: 0.37 – TI/Hi: 16/07

UPC: 842644063382



8 pc. Fried Chicken Bag 268245158 – Stock

◆ **CUSTOM PRINT PROGRAM MIN: 100,000 pcs.**

Material: Clear, Anti-fog PET/CPP

Description: Header Bag, Zipper, Vented, 2CF/2CB

Size: 14" x 7" + 5.5" + 1.5"

Case Pack: 250/case

Dim: 14.5" x 11" x 9" – Wgt: 12.8 lbs.

Cube: 0.83 – TI/Hi: 11/05

UPC: 842644067076



12 pc. Fried Chicken Bag 266165691 – Stock

◆ **CUSTOM PRINT PROGRAM MIN: 100,000 pcs.**

Material: Clear, Anti-fog PET/CPP

Description: Header Bag, Zipper, Vented, 2CF/2CB

Size: 17" x 7.5" + 7" + 1.5"

Case Pack: 250/case

Dim: 17.4" x 11.7" x 7.9" – Wgt: 12.8 lbs.

Cube: 0.93 – TI/Hi: 08/05

UPC: 842644067083





- ◆ Beautifully merchandise fruits and vegetables in these durable, convenient produce bags
- ◆ Steam Pouches are headered, microwave-safe, and are perfect for pre-packing a large variety of fresh vegetables
- ◆ Clear Produce bags are great for pre-packing and displaying fruits and vegetables
- ◆ Steam Pouches and Clear Produce bags have built-in handles for grab and go convenience
- ◆ For headered Steam Pouches, easy dispense racks and zipper bag quick closer tool available
- ◆ **CUSTOM PRINT PROGRAM:** Customize eligible items with your brand and design (up to 10 colors)
- ◆ Low minimum custom print runs with 12 week lead time from receipt of approved artwork

Hot Food Friendly
 Cold Food Friendly

Leak Resistant
 Microwavable

Custom Printing

Recyclable Item*
** If clean and dry
 Recyclability varies by item type
 Check with your local municipality/store*

STEAM POUCHES



12.75" x 7.5" + 3" + 1.5" Header Style Large Fresh Flavor Steam Pouch

261926308 – Stock

♦ CUSTOM PRINT PROGRAM MIN: 100,000 pcs.

Material: Clear, Anti-fog PET/CPP

Description: Header Bag, Zipper, Vented, 2CF/2CB

Size: 12.75" x 7.5" + 3" + 1.5"

Case Pack: 250/case

Dim: 13.4" x 9.8" x 6.5" – Wgt: 8.50 lbs.

Cube: 0.49 – TI/Hi: 14/07

UPC: 842644072520



7.5" x 7.5" + 4" + 1.5" Header Style Small Fresh Flavor Steam Pouch

263903632 – Stock

♦ CUSTOM PRINT PROGRAM MIN: 100,000 pcs.

Material: Clear, Anti-fog PET/CPP

Description: Header Bag, Zipper, Vented, 2CF/2CB

Size: 7.5" x 7.5" + 4" + 1.5"

Case Pack: 250/case

Dim: 11" x 8.2" x 6.5" – Wgt: 5.40 lbs.

Cube: 0.34 – TI/Hi: 20/07

UPC: 842644072513



CELERY BAGS



7" x 15" + 2" Celery Bag

326628800 – Stock

♦ CUSTOM PRINT PROGRAM MIN: 50,000 pcs.

Material: LDPE

Description: Loose Pack, 3CF/3CB

Size: 7" x 15" + 2"

Case Pack: 1,000/case

Dim: 15" x 8.3" x 2.6" – Wgt: 7.4 lbs.

Cube: 0.19 – TI/Hi: 14/18

UPC: 838702007740



CLEAR BAGS



10.5" x 3.75" + 4" + 2" Loose Pack Clear Produce Bag

260315886 – Stock

♦ CUSTOM PRINT PROGRAM MIN: 100,000 pcs.

Material: Clear, Anti-fog PET/CPP

Description: Loose Pack, Zipper, Vented

Size: 10.5" x 3.75" + 4" + 2"

Case Pack: 250/case

Dim: 11.2" x 6.5" x 5.9" – Wgt: 3.31 lbs.

Cube: 0.25 – TI/Hi: 26/07

UPC: 842644071318



10.75" x 9" + 4" + 1.5" Loose Pack Clear Produce Bag

267100089 – Stock

♦ CUSTOM PRINT PROGRAM MIN: 100,000 pcs.

Material: Clear, Anti-fog PET/CPP

Description: Loose Pack, Zipper, Vented

Size: 10.75" x 9" + 4" + 1.5"

Case Pack: 250/case

Dim: 11.6" x 11.2" x 5.9" – Wgt: 6.60 lbs.

Cube: 0.44 – TI/Hi: 12/07

UPC: 842644071325



8" x 6" x 16" PP Die Cut Bag

426869521-KD – Stock

Material: Clear PP

Description: Loose Pack, Die Cut Handle, Pinch Bottom

Size: 8" x 6" x 16"

Case Pack: 250/case

Dim: 17.3" x 9" x 3.5" – Wgt: 9.80 lbs.

Cube: 0.32 – TI/Hi: 10/14

UPC: 842644046484



PICKLE BAGS



6.4" x 10" Pickle Bag

234300100 – Stock

♦ CUSTOM PRINT PROGRAM MIN: 100,000 pcs.

Material: HDPE

Description: Flip Top, Saddle Pack, 1CF

Size: 6.4" x 10"

Case Pack: 1,000/case

Dim: 13" x 7.6" x 2" – Wgt: 2.8 lbs.

Cube: 0.11 – TI/Hi: 19/23

UPC: 838702002165



MICROWAVABLE STEAM POUCHES

MAKE SELLING & COOKING VEGGIES EASY WITH OUR STEAM POUCHES.

These easy to use, durable Steam Pouches showcase veggies beautifully and are convenient for stores and consumers alike.

- ♦ Available in two sizes for use with a large variety of vegetables
- ♦ Consumers can add seasonings, butter, and oils before placing in the microwave for steaming
- ♦ Instruction and suggested cooking times printed on-pack for ease of use
- ♦ The backside venting helps perfectly steam veggies
- ♦ Both sizes of Steam Pouches utilize our patented header system for ease of use





- ◆ Three sizes of Cookie Bags set up for convenience with easy loading header system and zipper closure
- ◆ Small Cookie Bags have retail style hang tab die cut for grab and go convenience in impulse buy areas
- ◆ Medium and large Cookie Bags have a built-in handle for grab and go convenience
- ◆ Made with non-vented, anti-fog film to keep cookies fresh
- ◆ Small case sizes equal lighter cases with a much smaller storage footprint compared to rigid plastic containers
- ◆ Easy dispense racks and zipper bag quick closer tool available
- ◆ **CUSTOM PRINT PROGRAM:** Customize eligible items with your brand and design (up to 10 colors)
- ◆ Low minimum custom print runs with 12 week lead time from receipt of approved artwork

 Hot Food Friendly

 Leak Resistant

 Microwavable

 Custom Printing

 Cold Food Friendly

COOKIE BAGS



Fresh Bakery Cookie Bag - Small

267962250 – Stock

♦ **CUSTOM PRINT PROGRAM MIN: 100,000 pcs.**

Material: Clear, Anti-fog PET/ CPP

Description: Header Bag, Zipper, Vented, 2CF/2CB

Size: 6" x 5" + 2" + 1.5"

Case Pack: 500/case

Dim: 8.5" x 6.5" x 12.2" – Wgt: 5.94 lbs.

Cube: 0.39 – TI/ HI: 32/03

UPC: 842644074067



Fresh Bakery Cookie Bag - Medium

264821681 – Stock

♦ **CUSTOM PRINT PROGRAM MIN: 100,000 pcs.**

Material: Clear, Anti-fog PET/ CPP

Description: Header Bag, Zipper, Vented, 2CF/2CB

Size: 10.75" x 5.5" + 4" + 1.5"

Case Pack: 250/case

Dim: 11.2" x 9.1" x 6.3" – Wgt: 5.94 lbs.

Cube: 0.37 – TI/ HI: 17/07

UPC: 842644074074



Fresh Bakery Cookie Bag - Large

265439454 – Stock

♦ **CUSTOM PRINT PROGRAM MIN: 100,000 pcs.**

Material: Clear, Anti-fog PET/ CPP

Description: Header Bag, Zipper, Vented, 2CF/2CB

Size: 12" x 6.25" + 4" + 1.5"

Case Pack: 250/case

Dim: 12.6" x 9.6" x 6.3" – Wgt: 7.15 lbs.

Cube: 0.44 – TI/ HI: 15/07

UPC: 842644074081



BAG RACKS

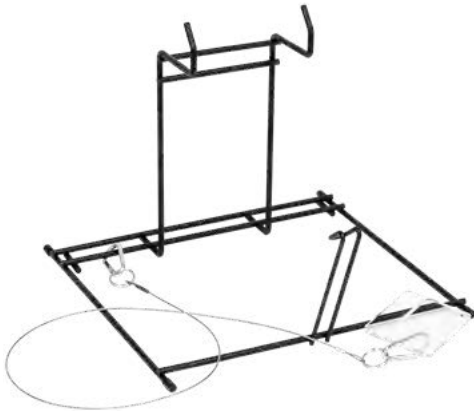

Counter Top Rack Kit With Holder

297144062 – Stock

Material: Wire, Safety Caps, Closer, Tether

Description: Countertop, Black Powder Coat

Size: 12.25" x 13.75"

Case Pack: 1/case

Dim: 13.7" x 13.7" x 11.3" – Wgt: 2.80 lbs.

Cube: 1.23 – TI/ HI: 12/03

UPC: 842644070014



5" Header Bag Rack

290367240 – Stock

Material: Aluminum

Description: Header Style 5, Black

Size: 5"

Case Pack: 1/case

UPC: 842644025939



T Bar Rack

290522864 – Stock

Material: Aluminum w/ Plastic Hook

Description: T Bar Rack, White

Size: Small

Case Pack: 1/case

UPC: 842644025953



INNOPAK VISIONS™ CARTONS



CUSTOM
PRINT
PROGRAM
ITEMS



- ◆ Patented, unique carton features a panoramic view is perfect for a variety of applications (*Patents D786,663 & D774,891*)
- ◆ Choose from 8", 9", 10", and 11" sizes
- ◆ Superior strength and stack-ability
- ◆ Made of durable CCSUS
- ◆ Crystal clear, heavy gauge PET window
- ◆ **CUSTOM PRINT PROGRAM:** Customize eligible items with your brand and design (up to 8 colors)
- ◆ Low minimum custom print runs with 12 week lead time from receipt of approved artwork

 Hot Food Friendly

 Cold Food Friendly

 Custom Printing

 Recyclable Item*
* If clean and dry
Remove window prior to recycling

SUPERIOR STACKING ABILITY

DON'T LET THE BIG WINDOW FOOL YOU.

The INNOPAK VISIONS™ Cartons are made to stack. Our unique design allows for even weight distribution keeping your products safe.

A TRUE MULTIPURPOSE CARTON.

The INNOPAK VISIONS™ Cartons are very versatile. Made from clay coated paperboard, croissants, muffins, cookies, tarts, pies, and more all fit and look great in these cartons.



INNOPAK VISIONS™ CARTONS



8" INNOPAK VISIONS™ Carton

018060317 – Stock

♦ **CUSTOM PRINT PROGRAM MIN: 25,000**

Material: CCSUS, PET Window

Description: GB Coat Inside

Size: 8.43" x 8.43" x 2.5"

Case Pack: 100/case

Dim: 14.4" x 9" x 11.6" – Wgt: 14.6 lbs.

Cube: 0.87 – TI/Hi: 10/03

UPC: 842644061067



9" INNOPAK VISIONS™ Carton

016636480 – Stock

♦ **CUSTOM PRINT PROGRAM MIN: 25,000**

Material: CCSUS, PET Window

Description: GB Coat Inside

Size: 9.43" x 9.43" x 2.5"

Case Pack: 100/case

Dim: 21.3" x 10.1" x 12.7" – Wgt: 18.4 lbs.

Cube: 1.58 – TI/Hi: 08/03

UPC: 842644061074



10" INNOPAK VISIONS™ Carton

013394873 – Stock

♦ **CUSTOM PRINT PROGRAM MIN: 25,000**

Material: CCSUS, PET Window

Description: GB Coat Inside

Size: 10.43" x 10.43" x 2.5"

Case Pack: 100/case

Dim: 25.2" x 11.1" x 13.6" – Wgt: 27.2 lbs.

Cube: 2.20 – TI/Hi: 06/03

UPC: 842644061081



INNOPAK VISIONS™ CARTONS



11" INNOPAK VISIONS™ Carton

019949578 – Make & Ship

♦ **CUSTOM PRINT PROGRAM MIN: 25,000**

Material: CCSUS, PET Window

Description: GB Coat Inside

Size: 11.43" x 11.43" x 2.5"

Case Pack: 100/case

Dim: 24.2" x 12.3" x 14.7" – Wgt: 30.3 lbs.

Cube: 2.53 – TI/Hi: 06/03

UPC: 842644067021



4" x 4" x 4" Cookie Carton

016754357 – Stock

♦ **CUSTOM PRINT PROGRAM MIN: 40,000 pcs.**

Material: Kraft

Description: Kraft, Windowed, Plain

Size: 4.0" x 4.0" x 4.0"

Case Pack: 200/case

Dim: 17.7" x 9.8" x 8.9" – Wgt: 12 lbs.

Cube: 0.89 – TI/Hi: 10/5

UPC: 842644075477





INNOPAK VISIONS™ CAKE CARTONS



CUSTOM
PRINT
PROGRAM
ITEMS



- ◆ Patented, unique carton features a panoramic view is perfect for a variety of applications (*Patents D786,663 & D774,891*)
- ◆ Choose from 8", 9", 10", and 11" sizes or the new 4" x 4" x 4" Cookie Carton
- ◆ Superior strength and stack-ability
- ◆ Made of durable CCSUS
- ◆ Crystal clear, heavy gauge PET window
- ◆ **CUSTOM PRINT PROGRAM:** Customize eligible items with your brand and design (up to 8 colors)
- ◆ Low minimum custom print runs with 12 week lead time from receipt of approved artwork

 Hot Food Friendly

 Cold Food Friendly

 Custom Printing

 Recyclable Item*

* If clean and dry
Remove window prior to recycling

INNOPAK VISIONS™ CAKE CARTONS



1/2 Sheet Cake Carton Kraft

093499267 – Make & Ship

♦ **CUSTOM PRINT PROGRAM MIN: 5,000**

Material: CORR, Kraft Out/Mottled Wht In, PP

Description: Hooded 6 Corner Glue

Size: 19" x 14" x 4"

Case Pack: 40/case

Dim: 21.5" x 20" x 20" – Wgt: 26.5 lbs.

Cube: 4.98 – TI/Hi: 04/04

UPC: 842644058777



1/4 Sheet Cake Carton Kraft

092861136 – Make & Ship

♦ **CUSTOM PRINT PROGRAM MIN: 5,000**

Material: CORR, Kraft Out/Mottled Wht In, PP

Description: Hooded 6 Corner Glue

Size: 14" x 10" x 4"

Case Pack: 50/case

Dim: 23.5" x 18.2" x 15" – Wgt: 21.4 lbs.

Cube: 3.6 – TI/Hi: 04/05

UPC: 842644058784



10" Cake Carton Kraft

098803653 – Make & Ship

♦ **CUSTOM PRINT PROGRAM MIN: 5,000**

Material: CORR, Kraft Out/Mottled Wht In, 2 PP

Description: Hooded 6 Corner Glue

Size: 10.75" x 10.75" x 5"

Case Pack: 50/case

Dim: 22.5" x 19.5" x 11.5" – Wgt: 21.5 lbs.

Cube: 2.92 – TI/Hi: 04/07

UPC: 842644058760



INNOPAK VISIONS™ CAKE CARTONS



1/2 Sheet Cake Carton White

093499267 – Make & Ship

♦ **CUSTOM PRINT PROGRAM MIN: 5,000**

Material: CORR, Bleach Wht Out/Mottled Wht In, PP

Description: Hooded 6 Corner Glue

Size: 19" x 14" x 4"

Case Pack: 40/case

Dim: 21.5" x 20" x 20" – Wgt: 26.5 lbs.

Cube: 4.98 – TI/Hi: 04/04

UPC: 842644058777



1/4 Sheet Cake Carton White

092861139 – Make & Ship

♦ **CUSTOM PRINT PROGRAM MIN: 5,000**

Material: CORR, Bleach Wht Out/Mottled Wht In, PP

Description: Hooded 6 Corner Glue

Size: 14" x 10" x 4"

Case Pack: 50/case

Dim: 23.5" x 18.2" x 15" – Wgt: 22.5 lbs.

Cube: 3.71 – TI/Hi: 04/05



10" Cake Carton White

098364565 – Make & Ship

♦ **CUSTOM PRINT PROGRAM MIN: 5,000**

Material: CORR, Bleach Wht Out/Mottled Wht In, PP

Description: Hooded 6 Corner Glue

Size: 10.75" x 10.75" x 5"

Case Pack: 50/case

Dim: 22.5" x 19.5" x 11.5" – Wgt: 21.5 lbs.

Cube: 2.92 – TI/Hi: 04/07

UPC: 842644058814



CORRUGATED CUPCAKE INSERT



12 Count Cupcake Insert

092619092 – Make & Ship

Material: CORR, Mottled White

Description: Cupcake Insert

Size: 15" x 10.625" x 0.75"

Case Pack: 100/case

Dim: 15.9" x 11.5" x 13.8" – Wgt: 8.5 lbs.

Cube: 1.46 – TI/Hi: 12/03

UPC: 842644058753



SUPERIOR STACKING ABILITY!!

DON'T LET THE BIG WINDOW FOOL YOU.

The INNOPAK VISIONS™ Corrugated Cake Cartons are made to stack. Our unique design allows for even weight distribution keeping your products safe.





CUPCAKE & MUFFIN RIGID PET CONTAINERS



- ◆ Rigid containers made from crystal clear PET for maximum product visibility
- ◆ Domed design features product and protects frosting decorations
- ◆ Durable containers designed to stack securely
- ◆ Available in 1, 2, 4, 6, 12, and 24 count configurations
- ◆ Container options for jumbo and mini cupcakes as well as muffins

 Cold Food Friendly

 Recyclable Item*
* If clean and dry
Check with your local municipality/store

CUPCAKE & MUFFIN RIGID PET CONTAINERS



1-Count Jumbo Cupcake Container Swirl Dome IP101 – Stock

Material: Clear, Rigid, PET
Description: Hinged
Size: 5.25" x 4"
Case Pack: 270/case
Dim: 23.5" x 12.2" x 16" – Wgt: 15.8 lbs.
Cube: 2.65 – TI/Hi: 06/06
UPC: 842644029227



2-Count Jumbo Cupcake Container IP202 – Stock

Description: Hinged
Material: Clear, Rigid, PET
Size: 8" x 5.25" x 3.8"
Case Pack: 220/case
Dim: 22.2" x 16.3" x 18.7" – Wgt: 22.4 lbs.
Cube: 3.92 – TI/Hi: 05/02
UPC: 842644041298



4-Count Cupcake Container IP404 – Stock

Material: Clear, Rigid, PET
Description: Hinged
Size: 7" x 6.5" x 3.75"
Case Pack: 225/case
Dim: 17.1" x 14.6" x 20.9" – Wgt: 18.5 lbs.
Cube: 3.02 – TI/Hi: 06/04
UPC: 842644054564



CUPCAKE & MUFFIN RIGID PET CONTAINERS



6-Count Cupcake Container IP456 – Stock

Material: Clear, Rigid, PET
Description: Hinged
Size: 9.63" x 6.88" x 3.7"
Case Pack: 150/case
Dim: 20.3" x 15.8" x 15" – Wgt: 18.15 lbs.
Cube: 2.78 – TI/Hi: 06/06
UPC: 842644021856



12-Count Cupcake Container IP412 – Stock

Description: Hinged
Material: Clear, Rigid, PET
Size: 12.38" x 10" x 3.7"
Case Pack: 100/case
Dim: 25.5" x 12.5" x 20.6" – Wgt: 22.0 lbs.
Cube: 3.80 – TI/Hi: 04/04
UPC: 842644021870



24-Count Cupcake Container IP424 – Stock

Material: Clear, Rigid, PET
Description: 2-piece
Size: 18" x 12.5" x 3.7"
Case Pack: 50/case
Dim: 25.1" x 12.5" x 19.3" – Wgt: 22.4 lbs.
Cube: 3.50 – TI/Hi: 04/02
UPC: 842644021863



CUPCAKE & MUFFIN RIGID PET CONTAINERS



24-Count Mini Cupcake Container IP224 – Stock

Material: Clear, Rigid, PET
Description: Hinged
Size: 12.38" x 10" x 2.25"
Case Pack: 110/case
Dim: 26" x 9.8" x 21.1" – Wgt: 22 lbs.
Cube: 3.11 – TI/Hi: 06/04
UPC: 842644040659



2-Count Muffin Container IP302 – Stock

Material: Clear, Rigid, PET
Description: Hinged
Size: 8" x 5.25" x 3.25"
Case Pack: 240/case
Dim: 22.2" x 16.3" x 18.7" – Wgt: 22.4 lbs.
Cube: 3.92 – TI/Hi: 05/02
UPC: 842644028169



4-Count Muffin Container IP524 – Stock

Material: Clear, Rigid, PET
Description: Hinged
Size: 8.25" x 8" x 3.3"
Case Pack: 200/case
Dim: 18" x 17.7" x 17.3" – Wgt: 21.6 lbs.
Cube: 3.19 – TI/Hi: 04/02
UPC: 842644037024





- ◆ ON TREND DESIGN perfect for any grocery store, bakery, or convenience store
- ◆ Comprehensive family of matched bakery packaging includes Kraft and SBS Cartons, HD Bags, Wax Bags, and Paper Bags
- ◆ Bakery cartons are automatic and have crystal clear windows
- ◆ Matching stock family of carryout packaging
- ◆ **CUSTOM PRINT PROGRAM:** Customize eligible items with your brand and design
- ◆ Low minimum custom print runs with 12 week lead time from receipt of approved artwork

 Hot Food Friendly
 Cold Food Friendly

 Leak Resistant

 Custom Printing

 Recyclable Item*
* If clean and dry
 Recyclability varies by item type
 Check with your local municipality/store
 Remove window prior to recycling

DONUT/SPECIALTY CARTONS - KRAFT



6" x 6" x 3" Carton - Fresh Flavor™
011600204 – Stock

♦ **CUSTOM PRINT PROGRAM MIN: 15,000 pcs.**

Material: Kraftpak, OPP Window

Description: Hooded 6 Corner

Size: 6" x 6" x 3"

Case Pack: 100/case

Dim: 12.8" x 9.4" x 9.8" – Wgt: 10 lbs.

Cube: 0.68 – TI/Hi: 15/04

UPC: 842644063832



9" x 4.5" x 4" Carton - Fresh Flavor™
013000204 – Stock

♦ **CUSTOM PRINT PROGRAM MIN: 15,000 pcs.**

Material: CCSUS, OPP Window

Description: Hooded 4 Corner

Size: 9" x 4.5" x 4"

Case Pack: 100/case

Dim: 16.8" x 9.1" x 9.8" – Wgt: 15.85 lbs.

Cube: 0.87 – TI/Hi: 10/04

UPC: 842644063764



10" x 8" x 4" Carton - Fresh Flavor™
013100203 – Stock

♦ **CUSTOM PRINT PROGRAM MIN: 15,000 pcs.**

Material: Kraftpak, OPP Window

Description: Hooded 6 Corner

Size: 10" x 8" x 4"

Case Pack: 100/case

Dim: 18.2" x 10.9" x 12.7" – Wgt: 20.4 lbs.

Cube: 1.46 – TI/Hi: 08/03

UPC: 842644063450



DONUT/SPECIALTY CARTONS - KRAFT



16" x 12" x 2.5" Carton - Fresh Flavor™
014579562 – Stock

♦ **CUSTOM PRINT PROGRAM MIN: 15,000 pcs.**

Material: Kraftpak, OPP Window

Description: Hooded 6 Corner

Size: 16" x 12" x 2.5"

Case Pack: 100/case

Dim: 22" x 16.8" x 15.4" – Wgt: 28 lbs.

Cube: 3.29 – TI/Hi: 04/03

UPC: 842644063474



CAKE CARTONS - KRAFT



9" x 9" x 4" Carton - Fresh Flavor™
098291720 – Stock

♦ **CUSTOM PRINT PROGRAM MIN: 15,000 pcs.**

Material: Kraftpak, OPP Window

Description: Hooded 4 Corner

Size: 9" x 9" x 4"

Case Pack: 100/case

Dim: 18.2" x 9.8" x 14.2" – Wgt: 22.2 lbs.

Cube: 1.47 – TI/Hi: 10/03

UPC: 842644063461



10" x 10" x 5" Carton - Fresh Flavor™
014300203 – Stock

♦ **CUSTOM PRINT PROGRAM MIN: 15,000 pcs.**

Material: Kraftpak, OPP Window

Description: Hooded 4 Corner

Size: 10" x 10" x 5"

Case Pack: 100/case

Dim: 23.7" x 15.3" x 11.1" – Wgt: 22.1 lbs.

Cube: 2.33 – TI/Hi: 05/04

UPC: 842644063498



CAKE CARTONS - KRAFT



14" x 10" x 4" Carton - Fresh Flavor™
015000203 – Stock

♦ **CUSTOM PRINT PROGRAM MIN: 15,000 pcs.**

Material: Kraftpak, OPP Window

Description: Hooded 4 Corner

Size: 14" x 10" x 4"

Case Pack: 100/case

Dim: 24.3" x 14.6" x 14.8" – Wgt: 35.4 lbs.

Cube: 3.04 – TI/Hi: 05/03

UPC: 842644063580



19" x 14" x 4" Carton - Fresh Flavor™
015100204 – Stock

♦ **CUSTOM PRINT PROGRAM MIN: 15,000 pcs.**

Material: Kraftpak, OPP Window

Description: Hooded 4 Corner

Size: 19" x 14" x 4"

Case Pack: 50/case

Dim: 18.9" x 13.3" x 19.9" – Wgt: 29 lbs.

Cube: 2.89 – TI/Hi: 07/02

UPC: 842644063634



26.5" x 18.63" x 3" Lid - Fresh Flavor™
015827667 – Stock

♦ **CUSTOM PRINT PROGRAM MIN: 15,000 pcs.**

Material: Kraftpak, OPP Window

Description: Hooded 4 Corner

Size: 26.5" x 18.63" x 3"

Case Pack: 50/case

Dim: 27.2" x 8.9" x 19.8" – Wgt: 21 lbs.

Cube: 2.77 – TI/Hi: 06/02

UPC: 842644063528



PIE CARTONS - KRAFT



8" x 8" x 2.5" Carton - Fresh Flavor™
011000203 – Stock

♦ **CUSTOM PRINT PROGRAM MIN: 11,000 pcs.**

Material: Kraftpak, OPP Window

Description: Hooded 4 Corner

Size: 8" x 8" x 2.5"

Case Pack: 100/case

Dim: 20.1" x 9" x 11.5" – Wgt: 13.8 lbs.

Cube: 1.20 – TI/Hi: 10/04

UPC: 842644063559



9" x 9" x 2.5" Carton - Fresh Flavor™
011000204 – Stock

♦ **CUSTOM PRINT PROGRAM MIN: 16,000 pcs.**

Material: Kraftpak, OPP Window

Description: Hooded 4 Corner

Size: 9" x 9" x 2.5"

Case Pack: 100/case

Dim: 16.3" x 12.2" x 9.8" – Wgt: 12.94 lbs.

Cube: 1.13 – TI/Hi: 10/04

UPC: 842644063887



10" x 10" x 2.5" Carton - Fresh Flavor™
011200204 – Stock

♦ **CUSTOM PRINT PROGRAM MIN: 13,500 pcs.**

Material: Kraftpak, OPP Window

Description: Hooded 4 Corner

Size: 10" x 10" x 2.5"

Case Pack: 100/case

Dim: 16.9" x 11" x 13.4" – Wgt: 18.41 lbs.

Cube: 1.44 – TI/Hi: 08/03

UPC: 842644063610



DONUT/SPECIALTY CARTONS - SBS



9" x 4.5" x 4" Carton - Fresh Flavor™
003000203 – Stock

♦ **CUSTOM PRINT PROGRAM MIN: 15,000 pcs.**

Material: SBS, OPP Window

Description: Hooded 4 Corner

Size: 9" x 4.5" x 4"

Case Pack: 100/case

Dim: 16.8" x 9.1" x 9.8" – Wgt: 14.25 lbs.

Cube: 0.87 – TI/Hi: 10/04

UPC: 842644063573



9" x 7" x 3.5" Carton - Fresh Flavor™
002000204 – Stock

♦ **CUSTOM PRINT PROGRAM MIN: 15,000 pcs.**

Material: SBS, OPP Window

Description: Hooded 6 Corner, Reduced Sidewall

Size: 9" x 7" x 3.5"

Case Pack: 100/case

Dim: 17.1" x 11.1" x 10" – Wgt: 12.6 lbs.

Cube: 1.10 – TI/Hi: 09/04

UPC: 842644063571



10" x 8" x 4" Carton - Fresh Flavor™
003100203 – Stock

♦ **CUSTOM PRINT PROGRAM MIN: 15,000 pcs.**

Material: SBS, OPP Window

Description: Hooded 6 Corner

Size: 10" x 8" x 4"

Case Pack: 100/case

Dim: 18.8" x 10.6" x 12.8" – Wgt: 19 lbs.

Cube: 1.48 – TI/Hi: 08/03

UPC: 842644063467



DONUT/SPECIALTY CARTONS - SBS



11.5" x 8" x 2" Carton - Fresh Flavor™
018341967 – Stock

♦ **CUSTOM PRINT PROGRAM MIN: 15,000 pcs.**

Material: SBS, OPP Window

Description: Hooded 4 Corner

Size: 11.5" x 8" x 2"

Case Pack: 150/case

Dim: 23" x 10.4" x 12.4" – Wgt: 17.9 lbs.

Cube: 1.57 – TI/Hi: 06/03

UPC: 842644072407



THE FRESH FLAVOR™ DESIGN

CARTONS AVAILABLE IN KRAFT AND SBS

This on trend design is perfect for any grocery store, bakery, or convenience store in need of a comprehensive bakery matched packaging line. Choose from a large selection of cartons and bags for all your merchandising needs. The matching carryout line of Fresh Flavor™ packaging is the perfect complement.

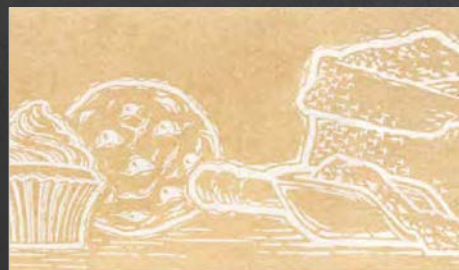

CAKE CARTONS - SBS



8" x 8" x 4" Carton - Fresh Flavor™
004000203 – Stock

♦ **CUSTOM PRINT PROGRAM MIN: 15,000 pcs.**

Material: SBS, OPP Window
 Description: Hooded 4 Corner
 Size: 8" x 8" x 4"
 Case Pack: 100/case
 Dim: 19.6" x 8.5" x 12.7" – Wgt: 15.2 lbs.
 Cube: 1.22 – TI/Hi: 10/03
 UPC: 842644063870



10" x 10" x 5" Carton - Fresh Flavor™
004300203 – Stock

♦ **CUSTOM PRINT PROGRAM MIN: 15,000 pcs.**

Material: SBS, OPP Window
 Description: Hooded 4 Corner, 3C
 Size: 10" x 10" x 5"
 Case Pack: 100/case
 Dim: 23.1" x 15.5" x 11" – Wgt: 29.8 lbs.
 Cube: 2.28 – TI/Hi: 05/04
 UPC: 842644043481



14" x 10" x 4" Carton - Fresh Flavor™
005000206 – Stock

♦ **CUSTOM PRINT PROGRAM MIN: 15,000 pcs.**

Material: SBS, OPP Window
 Description: Hooded 4 Corner
 Size: 14" x 10" x 4"
 Case Pack: 100/case
 Dim: 19.7" x 14.6" x 14.6" – Wgt: 35.6 lbs.
 Cube: 2.43 – TI/Hi: 06/03
 UPC: 842644063627



CAKE CARTONS - SBS



19" x 14" x 4" Carton - Fresh Flavor™
005100203 – Stock

♦ **CUSTOM PRINT PROGRAM MIN: 15,000 pcs.**

Material: SBS, OPP Window
 Description: Hooded 4 Corner
 Size: 19" x 14" x 4"
 Case Pack: 50/case
 Dim: 18.9" x 11.8" x 19.9" – Wgt: 31.4 lbs.
 Cube: 2.57 – TI/Hi: 08/02
 UPC: 842644063597



26.5" x 18.63" x 3" Lid - Fresh Flavor™
018474102 – Stock

♦ **CUSTOM PRINT PROGRAM MIN: 15,000 pcs.**

Material: SBS, OPP Window
 Description: 4 Corner Glue Lid
 Size: 26.5" x 18.63" x 3"
 Case Pack: 50/case
 Dim: 27.6" x 9.3" x 19.6" – Wgt: 15.4 lbs.
 Cube: 2.77 – TI/Hi: 06/02
 UPC: 842644063504



26" x 18" x 4" Full Sheet Corrugate Bases



Mix and match any full sheet cake lid with any full sheet corrugate base!

095245300 – White in/Kraft out
098309053 – White in/White out

Call your Inno-Pak sales representative today for more information or to place an order!

PIE CARTONS - SBS



8" x 8" x 2.5" Carton - Fresh Flavor™
001000203 – Stock

♦ **CUSTOM PRINT PROGRAM MIN: 11,000 pcs.**

Material: SBS, OPP Window
 Description: Hooded 4 Corner
 Size: 8" x 8" x 2.5"
 Case Pack: 100/case
 Dim: 20.1" x 8.9" x 11.4" – Wgt: 11.4 lbs.
 Cube: 1.18 – TI/Hi: 10/04
 UPC: 842644063566



9" x 9" x 2.5" Carton - Fresh Flavor™
001100203 – Stock

♦ **CUSTOM PRINT PROGRAM MIN: 16,000 pcs.**

Material: SBS, OPP Window
 Description: Hooded 4 Corner
 Size: 9" x 9" x 2.5"
 Case Pack: 100/case
 Dim: 16.6" x 12.2" x 10" – Wgt: 12.4 lbs.
 Cube: 1.17 – TI/Hi: 09/04
 UPC: 842644063894



10" x 10" x 2.5" Carton - Fresh Flavor™
001200203 – Stock

♦ **CUSTOM PRINT PROGRAM MIN: 13,500 pcs.**

Material: SBS, OPP Window
 Description: Hooded 4 Corner
 Size: 10" x 10" x 2.5"
 Case Pack: 100/case
 Dim: 17.1" x 11.2" x 13.3" – Wgt: 17.2 lbs.
 Cube: 1.47 – TI/Hi: 09/03
 UPC: 842644063603



WAX BAGS



4# Bleached - Fresh Flavor™

101000206 – Stock

Material: Bleached Kraft Wax

Description: Automatic, 1CF

Size: 4lb Wax Bag

Case Pack: 500/case

Dim: 12.7" x 13" x 7" – Wgt: 9.5 lbs.

Cube: 0.67 – TI/Hi: 09/07

UPC: 842644063740



6# Bleached - Fresh Flavor™

101200203 – Stock

Material: Bleached Kraft Wax

Description: Automatic, 1CF

Size: 6lb Wax Bag

Case Pack: 500/case

Dim: 14.5" x 17.5" x 6.6" – Wgt: 13.2 lbs.

Cube: 0.97 – TI/Hi: 06/09

UPC: 842644063702



8# Bleached - Fresh Flavor™

101300204 – Stock

Material: Bleached Kraft Wax

Description: Automatic, 1CF

Size: 8lb Wax Bag

Case Pack: 500/case

Dim: 16.7" x 12.7" x 7.5" – Wgt: 14.4 lbs.

Cube: 0.92 – TI/Hi: 08/05

UPC: 842644063726



PAPER BREAD BAGS



4.5" x 2.5" x 24" French Bread Bag - Fresh Flavor™

122100203 – Stock

Material: Bleached Kraft

Description: Pinch Bottom, 1CF

Size: 4.5" x 2.5" x 24"

Case Pack: 500/case

Dim: 31" x 10.5" x 4.6" – Wgt: 15.4 lbs.

Cube: 0.87 – TI/Hi: 04/09

UPC: 842644063722



4.5" x 2.5" x 28" French Bread Bag - Fresh Flavor™

122200205 – Stock

Material: Bleached Kraft

Description: Pinch Bottom, 1CF

Size: 4.5" x 2.5" x 28"

Case Pack: 500/case

Dim: 30.8" x 10.8" x 5.1" – Wgt: 16.8 lbs.

Cube: 0.98 – TI/Hi: 04/08

UPC: 842644063757



5.25" x 3.25" x 20" Italian Bread Bag - Fresh Flavor™

123100204 – Stock

Material: Bleached Kraft

Description: Pinch Bottom, 1CF

Size: 5.25" x 3.25" x 20"

Case Pack: 500/case

Dim: 21.3" x 18.5" x 5.4" – Wgt: 14 lbs.

Cube: 1.23 – TI/Hi: 08/07

UPC: 842644063733



PAPER BREAD BAGS



6" x 3.5" x 20" Italian Bread Bag - Fresh Flavor™

123300203 – Stock

Material: Bleached Kraft

Description: Pinch Bottom, 1CF

Size: 6" x 3.5" x 20"

Case Pack: 500/case

Dim: 24" x 10.1" x 6.7" – Wgt: 15.75 lbs.

Cube: 0.94 – TI/Hi: 08/06

UPC: 842644063719



5.25" x 3.25" x 20" Garlic Bread Bag - Fresh Flavor™

144100204 – Stock

Material: Silver Foil

Description: Pinch Bottom, 1CF

Size: 5.25" x 3.25" x 20"

Case Pack: 500/case

Dim: 27.7" x 10" x 5.7" – Wgt: 15 lbs.

Cube: 0.91 – TI/Hi: 06/07

UPC: 842644063696



PP/HDPE BAGS



6" x 4" x 14" HD Bag - Fresh Flavor™

201200203 – Stock

♦ **CUSTOM PRINT PROGRAM MIN: 50,000 pcs.**

Material: Clear Embossed HDPE

Description: Loose Pack, 1CF

Size: 6" x 4" x 14"

Case Pack: 1,000/case

Dim: 13" x 7.9" x 4.3" – Wgt: 7.93 lbs.

Cube: 0.26 – TI/Hi: 18/10

UPC: 842644063955





- ◆ Circular, rectangular, and scalloped corrugated pads available in gold and bright white
- ◆ Available coated and uncoated
- ◆ Available in single wall or double wall
- ◆ Choose from a large variety of sizes

 Hot Food Friendly

 Cold Food Friendly

 Gloss Surface *(Gold Foil Only)*

WHITE - SINGLE WALL - UNCOATED

7" Corrugated Circle - White

093803001 – Stock

Material: Single Wall Corrugate

Description: Uncoated

Size: 7"

Case Pack: 500/case

Dim: 14.3" x 14.6" x 21" – Wgt: 15.4 lbs.

Cube: 2.54 – TI/Hi: 06/02

UPC: 842644004507



9" Corrugated Circle - White

093103001 – Stock

Material: Single Wall Corrugate

Description: Uncoated

Size: 9"

Case Pack: 250/case

Dim: 18.5" x 9.5" x 20.8" – Wgt: 12.6 lbs.

Cube: 2.21 – TI/Hi: 10/02

UPC: 842644004521



10" Corrugated Circle - White

093203002 – Stock

Material: Single Wall Corrugate

Description: Uncoated

Size: 10"

Case Pack: 250/case

Dim: 20.5" x 10.6" x 21" – Wgt: 15.7 lbs.

Cube: 2.64 – TI/Hi: 08/02

UPC: 842644024574



WHITE - SINGLE WALL - UNCOATED

14" Corrugated Circle - White

093403002 – Stock

Material: Single Wall Corrugate

Description: Uncoated

Size: 14"

Case Pack: 125/case

Dim: 14.6" x 14.3" x 20.8" – Wgt: 15.4 lbs.

Cube: 2.51 – TI/Hi: 06/02

UPC: 842644024598



16" Corrugated Circle - White

093503002 – Stock

Material: Single Wall Corrugate

Description: Uncoated

Size: 16"

Case Pack: 125/case

Dim: 16.5" x 16.5" x 21.2" – Wgt: 20 lbs.

Cube: 3.34 – TI/Hi: 06/02

UPC: 842644024604



WHITE - SINGLE WALL - COATED

8" Corrugated Circle - White

093002001 – Stock

Material: Single Wall Corrugate

Description: Coated

Size: 8"

Case Pack: 500/case

Dim: 24.3" x 16.6" x 14.2" – Wgt: 21.4 lbs.

Cube: 3.31 – TI/Hi: 04/03

UPC: 842644004750



WHITE - SINGLE WALL - COATED

9" Corrugated Circle - White

093102001 – Stock

Material: Single Wall Corrugate

Description: Coated

Size: 9"

Case Pack: 250/case

Dim: 18.5" x 9.6" x 20.8" – Wgt: 12.6 lbs.

Cube: 2.14 – TI/Hi: 10/02

UPC: 842644004767



10" Corrugated Circle - White

093202001 – Stock

Material: Single Wall Corrugate

Description: Coated

Size: 10"

Case Pack: 250/case

Dim: 20.6" x 10.6" x 21" – Wgt: 16.8 lbs.

Cube: 2.65 – TI/Hi: 08/02

UPC: 842644004774



1/8 Sheet Corrugated Pad - White

091002001 – Stock

Material: Single Wall Corrugate

Description: Coated

Size: 9.75" x 7.75"

Case Pack: 200/case

Dim: 20" x 16.2" x 9" – Wgt: 13.2 lbs.

Cube: 1.69 – TI/Hi: 06/05

UPC: 842644004699



WHITE - SINGLE WALL - COATED

1/4 Sheet Corrugated Pad - White

091102001 – Stock

Material: Single Wall Corrugate

Description: Coated

Size: 13.75" x 9.75"

Case Pack: 100/case

Dim: 20" x 14.3" x 8.8" – Wgt: 11.8 lbs.

Cube: 1.46 – TI/Hi: 06/05

UPC: 842644004705



1/2 Sheet Corrugated Pad - White

091202001 – Stock

Material: Single Wall Corrugate

Description: Coated

Size: 18.75" x 13.75"

Case Pack: 50/case

Dim: 20" x 14.5" x 8.8" – Wgt: 11.4 lbs.

Cube: 1.48 – TI/Hi: 06/05

UPC: 842644004712



Full Sheet Corrugated Pad - White

091302001 – Stock

Material: Single Wall Corrugate

Description: Coated

Size: 25.5" x 17.5"

Case Pack: 50/case

Dim: 25.7" x 18.1" x 8.7" – Wgt: 19 lbs.

Cube: 2.34 – TI/Hi: 03/05

UPC: 842644004729



WHITE - SINGLE WALL - COATED

26" x 18" x 4" Full Sheet Corrugate

095245300 – Stock

Material: Single Wall Corrugate

Description: Coated, Brw Out/Wht In

Size: 26" x 18" x 4"

Case Pack: 50/case

Dim: 35" x 6.7" x 27.1" – Wgt: 35.4 lbs.

Cube: 3.68 – TI/Hi: 08/01

UPC: 838702009249



26" x 18" x 4" Full Sheet Corrugate

098309053 – Stock

Material: Single Wall Corrugate

Description: Coated, Wht Out/Wht In

Size: 26" x 18" x 4"

Case Pack: 50/case

Dim: 38" x 6.7" x 29.2" – Wgt: 34.4 lbs.

Cube: 4.30 – TI/Hi: 08/01

UPC: 842644052898



26" x 18" x 5" Full Sheet Corrugate

099842396 – Make & Ship

Material: Single Wall Corrugate

Description: Coated, Wht Out/Wht In

Size: 26" x 18" x 5"

Case Pack: 50/case

Dim: 29.5" x 7" x 38" – Wgt: 40.2 lbs.

Cube: 4.54 – TI/Hi: 08/01

UPC: 842644024024



GOLD - SINGLE WALL - COATED

6.25" Corrugated Circle - Gold 093704001 – Stock

Material: Single Wall Corrugate
Description: Coated, Scalloped
Size: 6.25"

Case Pack: 200/case
Dim: 13" x 13" x 8.8" – Wgt: .75 lbs.
Cube: 0.86 – TI/HI: 09/05
UPC: 842644004637



8" Corrugated Circle - Gold 093004001 – Stock

Material: Single Wall Corrugate
Description: Coated, Scalloped
Size: 8"

Case Pack: 200/case
Dim: 16.7" x 8.8" x 17.1" – Wgt: 8.6 lbs.
Cube: 1.45 – TI/HI: 04/05
UPC: 842644004644



9" Corrugated Circle - Gold 093104001 – Stock

Material: Single Wall Corrugate
Description: Coated, Scalloped
Size: 9"

Case Pack: 200/case
Dim: 18.5" x 18.5" x 8.7" – Wgt: 11.4 lbs.
Cube: 1.72 – TI/HI: 04/05
UPC: 842644004651



GOLD - SINGLE WALL - COATED

10" Corrugated Circle - Gold 093204001 – Stock

Material: Single Wall Corrugate
Description: Coated, Scalloped
Size: 10"

Case Pack: 200/case
Dim: 20.6" x 20.5" x 8.7" – Wgt: 13.8 lbs.
Cube: 2.13 – TI/HI: 06/02
UPC: 842644004668



12" Corrugated Circle - Gold 093304002 – Stock

Material: Single Wall Corrugate
Description: Coated, Scalloped
Size: 12"

Case Pack: 100/case
Dim: 24.7" x 12.7" x 9" – Wgt: 9.75 lbs.
Cube: 1.63 – TI/HI: 06/05
UPC: 842644004675



1/8 Sheet Corrugated Pad - Gold 091004001 – Stock

Material: Single Wall Corrugate
Description: Coated, Scalloped
Size: 9.75" x 7.75"

Case Pack: 200/case
Dim: 20" x 16.1" x 9" – Wgt: 12 lbs.
Cube: 1.68 – TI/HI: 06/05
UPC: 842644004590



GOLD - SINGLE WALL - COATED

1/4 Sheet Corrugated Pad - Gold 091104001 – Stock

Material: Single Wall Corrugate
Description: Coated, Scalloped
Size: 13.75" x 9.75"

Case Pack: 100/case
Dim: 20.1" x 14.5" x 9" – Wgt: 12.2 lbs.
Cube: 1.52 – TI/HI: 06/05
UPC: 842644004606



1/2 Sheet Corrugated Pad-Gold 091204001 – Stock

Material: Single Wall Corrugate
Description: Coated, Scalloped
Size: 18.75" x 13.75"

Case Pack: 50/case
Dim: 19.8" x 15" x 9" – Wgt: 11 lbs.
Cube: 1.55 – TI/HI: 06/05
UPC: 842644004613



Full Sheet Corrugated Pad-Gold 091304001 – Stock

Material: Single Wall Corrugate
Description: Coated, Scalloped
Size: 25.5" x 17.5"

Case Pack: 50/case
Dim: 25.7" x 18.1" x 8.8" – Wgt: 19.6 lbs.
Cube: 2.37 – TI/HI: 03/05
UPC: 842644004620



GOLD - DOUBLE WALL - COATED

1/2 Sheet Corrugated Pad - Gold 092204001 – Stock

Material: Double Wall Corrugate
Description: Coated, Scalloped
Size: 18.75" x 13.75"

Case Pack: 25/case
Dim: 19.8" x 14.5" x 7.2" – Wgt: 9 lbs.
Cube: 1.20 – TI/HI: 06/06
UPC: 84264405085



Full Sheet Corrugated Pad - Gold 092304001 – Stock

Material: Double Wall Corrugate
Description: Coated, Scalloped
Size: 25.5" x 17.5"

Case Pack: 25/case
Dim: 26" x 18" x 8" – Wgt: 16.7 lbs.
Cube: 2.17 – TI/HI: 03/05
UPC: 842644005092



INNOVATIVE IDEAS



- ◆ Made from crystal clear film
- ◆ Engineered for strength and freezer protection
- ◆ **CUSTOM PRINT PROGRAM:** Customize eligible items with your brand and design (up to 8 colors)
- ◆ Low minimum custom print runs with 12 week lead time from receipt of approved artwork

 Cold Food Friendly

 Custom Printing

BOTTOM GUSSET

8" x 22" + 3" PP Bakery Bag 420400101 – Stock

♦ CUSTOM PRINT PROGRAM MIN: 100,000 pcs.

Material: Superprope
Description: Loose Pack
Size: 8" x 22" + 3"

Case Pack: 1,000/case
Dim: 12.2" x 9.1" x 4" – Wgt: 10.03 lbs.
Cube: 0.26 – TI/Hi: 17/11
UPC: 838702004862



8.5" x 10" + 3" PP Bakery Bag 425776608 – Make & Ship

♦ CUSTOM PRINT PROGRAM MIN: 100,000 pcs.

Material: Superprope
Description: Loose Pack
Size: 8.5" x 10" + 3"

Case Pack: 1,000/case
Dim: 10.6" x 9.4" x 2.4" – Wgt: 5.56 lbs.
Cube: 0.14 – TI/Hi: 16/16
UPC: 842644013967



8.5" x 26" + 3" PP Bakery Bag 420700101 – Stock

♦ CUSTOM PRINT PROGRAM MIN: 100,000 pcs.

Material: Superprope
Description: Loose Pack
Size: 8.5" x 26" + 3"

Case Pack: 1,000/case
Dim: 13.8" x 9.4" x 3.9" – Wgt: 11.9 lbs.
Cube: 0.29 – TI/Hi: 13/12
UPC: 838702004305



BOTTOM GUSSET

9" x 13" + 4" PP Bakery Bag 421386227 – Stock

♦ CUSTOM PRINT PROGRAM MIN: 100,000 pcs.

Material: Superprope
Description: Loose Pack
Size: 9" x 13" + 4"

Case Pack: 1,000/case
Dim: 14" x 9.6" x 2.5" – Wgt: 6.61 lbs.
Cube: 0.19 – TI/Hi: 13/18
UPC: 842644013769



9" x 16" + 4" PP Bakery Bag 420900101 – Stock

♦ CUSTOM PRINT PROGRAM MIN: 100,000 pcs.

Material: Superprope
Description: Loose Pack
Size: 9" x 16" + 4"

Case Pack: 1,000/case
Dim: 16.9" x 9.5" x 2.6" – Wgt: 8.8 lbs.
Cube: 0.24 – TI/Hi: 10/18
UPC: 838702004879



10" x 16" + 4" PP Bakery Bag 421100101 – Stock

♦ CUSTOM PRINT PROGRAM MIN: 100,000 pcs.

Material: Superprope
Description: Loose Pack
Size: 10" x 16" + 4"

Case Pack: 1,000/case
Dim: 11.2" x 10.2" x 3.9" – Wgt: 9.04 lbs.
Cube: 0.26 – TI/Hi: 14/10
UPC: 838702004886



BOTTOM GUSSET

10.25" x 17" + 4" PP Bakery Bag 426377406 – Stock

♦ CUSTOM PRINT PROGRAM MIN: 100,000 pcs.

Material: Superprope
Description: Loose Pack
Size: 10.25" x 17" + 4"

Case Pack: 1,000/case
Dim: 18" x 10.8" x 2.5" – Wgt: 10 lbs.
Cube: 0.28 – TI/Hi: 08/18
UPC: 842644013974



10.5" x 17" + 4" Bakery PP Bag 425401140 – Stock

♦ CUSTOM PRINT PROGRAM MIN: 100,000 pcs.

Material: Superprope
Description: Loose Pack
Size: 10.5" x 17" + 4"

Case Pack: 1,000/case
Dim: 11.2" x 10.1" x 4.3" – Wgt: 9.9 lbs.
Cube: 0.28 – TI/Hi: 16/10
UPC: 842644049027



11" x 13.5" + 3" PP Bakery Bag 421400101 – Stock

♦ CUSTOM PRINT PROGRAM MIN: 100,000 pcs.

Material: Superprope
Description: Loose Pack
Size: 11" x 13.5" + 3"

Case Pack: 1,000/case
Dim: 14.2" x 12.1" x 2.5" – Wgt: 8.4 lbs.
Cube: 0.25 – TI/Hi: 11/18
UPC: 838702004893



BOTTOM GUSSET

12" x 16" + 4" PP Bakery Bag 421500101 – Stock

♦ CUSTOM PRINT PROGRAM MIN: 100,000 pcs.

Material: Superprope
Description: Loose Pack
Size: 12" x 16" + 4"

Case Pack: 1,000/case
Dim: 16.9" x 12.7" x 2.5" – Wgt: 10.6 lbs.
Cube: 0.31 – TI/Hi: 08/18
UPC: 838702004909



14" x 16" + 4" PP Bakery Bag 452573778 – Stock

♦ CUSTOM PRINT PROGRAM MIN: 100,000 pcs.

Material: Superprope
Description: Loose Pack
Size: 14" x 16" + 4"

Case Pack: 1,000/case
Dim: 16.7" x 15" x 2.4" – Wgt: 14.77 lbs.
Cube: 0.35 – TI/Hi: 06/19
UPC: 842644024406



12" x 20" + 4" PP Bakery Bag 421600101 – Stock

♦ CUSTOM PRINT PROGRAM MIN: 100,000 pcs.

Material: Superprope
Description: Loose Pack
Size: 12" x 20" + 4"

Case Pack: 1,000/case
Dim: 13.2" x 11.3" x 4.5" – Wgt: 14.8 lbs.
Cube: 0.39 – TI/Hi: 12/18
UPC: 838702003483



WICKET BOTTOM GUSSET

7" x 26.5" + 0" + 1.5" PP Bakery Bag 433900100 – Stock

♦ CUSTOM PRINT PROGRAM MIN: 100,000 pcs.

Material: Superprope
Description: Wicketed
Size: 7" x 26.5" + 0" + 1.5"

Case Pack: 1,000/case
Dim: 14.6" x 7.7" x 3.5" – Wgt: 9.48 lbs.
Cube: 0.23 – TI/Hi: 15/13
UPC: 842644005450



9" x 18" + 4" + 1.5" PP Bakery Bag 433400101 – Stock

♦ CUSTOM PRINT PROGRAM MIN: 100,000 pcs.

Material: Superprope
Description: Wicketed
Size: 9" x 18" + 4" + 1.5"

Case Pack: 1,000/case
Dim: 20.5" x 10" x 2.3" – Wgt: 9.7 lbs.
Cube: 0.27 – TI/Hi: 08/20
UPC: 838702006088



9" x 13" + 4" + 1.5" PP Bakery Bag 430800101 – Stock

♦ CUSTOM PRINT PROGRAM MIN: 100,000 pcs.

Material: Superprope
Description: Wicketed
Size: 9" x 13" + 4" + 1.5"

Case Pack: 1,000/case
Dim: 15.4" x 9.9" x 2.5" – Wgt: 7.2 lbs.
Cube: 0.22 – TI/Hi: 13/19
UPC: 838702004343



WICKET BOTTOM GUSSET

11" x 13.5" + 3" + 1.5" PP Bakery Bag

431400101 – Stock

♦ CUSTOM PRINT PROGRAM MIN: 100,000 pcs.

Material: Superprope

Description: Wicketed

Size: 11" x 13.5" + 3" + 1.5"

Case Pack: 1,000/case

Dim: 15.8" x 11.7" x 2.4" – Wgt: 9.24 lbs.

Cube: 0.26 – TI/Hi: 10/19

UPC: 838702006064



9.75" x 16" + 3" + 1.5" PP Bakery Bag

431401997 – Stock

♦ CUSTOM PRINT PROGRAM MIN: 100,000 pcs.

Material: Superprope +EVA

Description: Wicketed

Size: 9.75" x 16" + 3" + 1.5"

Case Pack: 1,000/case

Dim: 18.5" x 10.7" x 2.5" – Wgt: 9.2 lbs.

Cube: 0.29 – TI/Hi: 08/18

UPC: 842644039165



8" x 22" + 3" + 1.5" PP Bakery Bag

430400101 – Stock

♦ CUSTOM PRINT PROGRAM MIN: 100,000 pcs.

Material: Superprope

Description: Wicketed

Size: 8" x 22" + 3" + 1.5"

Case Pack: 1,000/case

Dim: 12.6" x 8.8" x 4.2" – Wgt: 9.48 lbs.

Cube: 0.27 – TI/Hi: 16/11

UPC: 838702006057



WICKET BOTTOM GUSSET

11" x 14" + 4" + 1.5" PP Bakery Bag

432600101 – Stock

♦ CUSTOM PRINT PROGRAM MIN: 100,000 pcs.

Material: Superprope

Description: Wicketed

Size: 11" x 14" + 4" + 1.5"

Case Pack: 1,000/case

Dim: 16.7" x 11.8" x 2.4" – Wgt: 9.6 lbs.

Cube: 0.27 – TI/Hi: 08/19

UPC: 838702004060



11" x 17" + 4" + 1.5" PP Bakery Bag

432700100 – Stock

♦ CUSTOM PRINT PROGRAM MIN: 100,000 pcs.

Material: Superprope

Description: Wicketed

Size: 11" x 17" + 4" + 1.5"

Case Pack: 1,000/case

Dim: 19.8" x 11.8" x 2.5" – Wgt: 13.6 lbs.

Cube: 0.34 – TI/Hi: 08/18

UPC: 842644005443



11" x 18" + 4" + 1.5" PP Bakery Bag

432800101 – Stock

♦ CUSTOM PRINT PROGRAM MIN: 100,000 pcs.

Material: Superprope

Description: Wicketed

Size: 11" x 18" + 4" + 1.5"

Case Pack: 1,000/case

Dim: 20.5" x 11.8" x 2.2" – Wgt: 12 lbs.

Cube: 0.31 – TI/Hi: 08/21

UPC: 838702003148



WICKET BOTTOM GUSSET

11" x 20.5" + 4" + 1.5" PP Bakery Bag

466300102 – Stock

♦ CUSTOM PRINT PROGRAM MIN: 100,000 pcs.

Material: Superprope

Description: Wicketed

Size: 11" x 20.5" + 4" + 1.5"

Case Pack: 1,000/case

Dim: 12.6" x 12.2" x 4.3" – Wgt: 12.78 lbs.

Cube: 0.38 – TI/Hi: 12/10

UPC: 842644007676



12" x 16" + 4" + 1.5" PP Bakery Bag

431500101 – Stock

♦ CUSTOM PRINT PROGRAM MIN: 100,000 pcs.

Material: Superprope

Description: Wicketed

Size: 12" x 16" + 4" + 1.5"

Case Pack: 1,000/case

Dim: 18.7" x 12.8" x 2.4" – Wgt: 11.66 lbs.

Cube: 0.33 – TI/Hi: 07/19

UPC: 838702004046



CLEAR SIDE GUSSET LOOSE

4.5" x 4" x 28" PP Bakery Bag

424000101 – Stock

♦ CUSTOM PRINT PROGRAM MIN: 100,000 pcs.

Material: Superprope

Description: Loose Pack

Size: 4.5" x 4" x 28"

Case Pack: 1,000/case

Dim: 15" x 5.1" x 6.7" – Wgt: 11.68 lbs.

Cube: 0.30 – TI/Hi: 24/07

UPC: 838702005722



CLEAR SIDE GUSSET LOOSE

5" x 4" x 15" PP Bakery Bag

424100101 – Stock

♦ CUSTOM PRINT PROGRAM MIN: 100,000 pcs.

Material: Superprope

Description: Loose Pack

Size: 5" x 4" x 15"

Case Pack: 1,000/case

Dim: 15.8" x 5.8" x 3.7" – Wgt: 6.2 lbs.

Cube: 0.20 – TI/Hi: 21/12

UPC: 838702005739



5" x 4" x 20" PP Bakery Bag

424200101 – Stock

♦ CUSTOM PRINT PROGRAM MIN: 100,000 pcs.

Material: Superprope

Description: Loose Pack

Size: 5" x 4" x 20"

Case Pack: 1,000/case

Dim: 11.2" x 5.8" x 6.7" – Wgt: 8.6 lbs.

Cube: 0.25 – TI/Hi: 28/06

UPC: 838702005746



8" x 4" x 22" PP Bakery Bag

424300101 – Stock

♦ CUSTOM PRINT PROGRAM MIN: 100,000 pcs.

Material: Superprope

Description: Loose Pack

Size: 8" x 4" x 22"

Case Pack: 1,000/case

Dim: 12.1" x 8.8" x 6.5" – Wgt: 12.8 lbs.

Cube: 0.40 – TI/Hi: 17/07

UPC: 838702005753



INNOVATIVE IDEAS



- ◆ Both windowed paper bags and clear PP bags available
- ◆ Crystal clear windows/film
- ◆ Micro-perforated bags available
- ◆ **CUSTOM PRINT PROGRAM:** Customize eligible items with your brand and design (up to 10 colors)
- ◆ Low minimum custom print runs with 12 week lead time from receipt of approved artwork

 Hot Food Friendly

 Custom Printing

PAPER WINDOW PANEL

4.5" x 2.5" x 28" Window Panel Bag

91-428WDN – Stock

♦ CUSTOM PRINT PROGRAM MIN: 100,000 pcs.

Material: Kraft Bag, PP Window

Description: Wheat, Window Bag, 1C

Size: 4.5" x 2.5" x 28"

Case Pack: 1,000/case

Dim: 29.5" x 9" x 9.5" – Wgt: 30.6 lbs.

Cube: 1.46 – TI/Hi: 05/04

UPC: 842644016388



5.25" x 3.25" x 20" Window Panel Bag

91-520WDN – Stock

♦ CUSTOM PRINT PROGRAM MIN: 100,000 pcs.

Material: Kraft Bag, PP Window

Description: Wheat, Window Bag, 1C

Size: 5.25" x 3.25" x 20"

Case Pack: 1,000/case

Dim: 27.5" x 18.5" x 5.4" – Wgt: 26.8 lbs.

Cube: 1.59 – TI/Hi: 03/07

UPC: 20674970100943



6.5" x 2" x 18" Window Panel Bag

91-632WDN – Stock

♦ CUSTOM PRINT PROGRAM MIN: 100,000 pcs.

Material: Kraft Bag, PP Window

Description: Wheat, Window Bag, 1C

Size: 6.5" x 2" x 18"

Case Pack: 1,000/case

Dim: 19.6" x 15.6" x 8.5" – Wgt: 22 lbs.

Cube: 1.50 – TI/Hi: 06/05

UPC: 838702001434



PAPER WINDOW PANEL

8.5" x 3" x 14" Window Panel Bag

91-814WDN – Stock

♦ CUSTOM PRINT PROGRAM MIN: 100,000 pcs.

Material: Kraft Bag, PP Window

Description: Wheat, Window Bag, 1C

Size: 8.5" x 3" x 14"

Case Pack: 1,000/case

Dim: 20.6" x 15" x 9.4" – Wgt: 24 lbs.

Cube: 1.68 – TI/Hi: 05/04

UPC: 20674970100271



MICRO-PERF WICKET

10" x 16" + 0" + 1.5" PP Bakery Bag

465852657 – Stock

♦ CUSTOM PRINT PROGRAM MIN: 100,000 pcs.

Material: BOPP

Description: Wicketed, Micro-Perf

Size: 10" x 16" + 0" + 1.5"

Case Pack: 1,000/case

Dim: 18.8" x 11.2" x 3.8" – Wgt: 9.4 lbs.

Cube: 0.46 – TI/Hi: 08/12

UPC: 838702005579



6" x 28" + 0" + 1.5" PP Bakery Bag

467382644 – Stock

♦ CUSTOM PRINT PROGRAM MIN: 100,000 pcs.

Material: BOPP

Description: Wicketed, Micro-Perf

Size: 6" x 28" + 0" + 1.5"

Case Pack: 1,000/case

Dim: 30.2" x 7.2" x 3.7" – Wgt: 9.2 lbs.

Cube: 0.47 – TI/Hi: 07/12

UPC: 842644015718



MICRO-PERF WICKET

11" x 20" + 0" + 1.5" PP Bakery Bag

466262387 – Stock

♦ CUSTOM PRINT PROGRAM MIN: 100,000 pcs.

Material: BOPP

Description: Wicketed, Micro-Perf

Size: 11" x 20" + 0" + 1.5"

Case Pack: 1,000/case

Dim: 22.4" x 12" x 3.5" – Wgt: 13.4 lbs.

Cube: 0.54 – TI/Hi: 06/13

UPC: 838702005593



13" x 18" + 0" + 1.5" PP Bakery Bag

466500101 – Stock

♦ CUSTOM PRINT PROGRAM MIN: 100,000 pcs.

Material: BOPP

Description: Wicketed, Micro-Perf

Size: 13" x 18" + 0" + 1.5"

Case Pack: 1,000/case

Dim: 20.5" x 14.2" x 3.6" – Wgt: 13.4 lbs.

Cube: 0.61 – TI/Hi: 06/12

UPC: 838702005630



MICRO-PERF LOOSE

6" x 28" PP Bakery Bag

456000101 – Stock

♦ CUSTOM PRINT PROGRAM MIN: 100,000 pcs.

Material: BOPP

Description: Loose Pack, Micro-Perf

Size: 6" x 28"

Case Pack: 1,000/case

Dim: 29.1" x 7.1" x 3.9" – Wgt: 9.41 lbs.

Cube: 0.47 – TI/Hi: 07/11

UPC: 838702004312



MICRO-PERF LOOSE

10" x 16" PP Bakery Bag

456200100 – Stock

♦ CUSTOM PRINT PROGRAM MIN: 100,000 pcs.

Material: BOPP

Description: Loose Pack, Micro-Perf

Size: 10" x 16"

Case Pack: 1,000/case

Dim: 17.2" x 11.1" x 4" – Wgt: 8.6 lbs.

Cube: 0.44 – TI/Hi: 09/11

UPC: 838702004190



11" x 20" PP Bakery Bag

456300101 – Stock

♦ CUSTOM PRINT PROGRAM MIN: 100,000 pcs.

Material: BOPP

Description: Loose Pack, Micro-Perf

Size: 11" x 20"

Case Pack: 1,000/case

Dim: 21.3" x 11.8" x 3.5" – Wgt: 12.28 lbs.

Cube: 0.51 – TI/Hi: 06/13

UPC: 838702005500



INNOVATIVE IDEAS



- ◆ Made from high clarity LDPE film
- ◆ Engineered for strength and freezer protection
- ◆ **CUSTOM PRINT PROGRAM:** Customize eligible items with your brand and design (up to 10 colors)
- ◆ Custom print runs with 12 week lead time from receipt of approved artwork

 Cold Food Friendly

 Custom Printing

 Recyclable Item*
*If clean and dry
Check with your local municipality/store

CLEAR BOTTOM GUSSET

7" x 15" + 2"

LD Produce Bag Celery

326628800 – Stock

♦ CUSTOM PRINT PROGRAM MIN:
50,000 pcs.

Material: Clear Smooth LDPE

Description: Loose, Celery, 3CF/2CB

Size: 7" x 15" + 2"

Case Pack: 1,000/case

Dim: 15" x 8.3" x 2.6" – Wgt: 7.4 lbs.

Cube: 0.19 – TI/Hi: 14/18

UPC: 838702007740



CLEAR WICKET BOTTOM GUSSET

9" x 13" + 4" + 1.5" LD Poly Bag

339500100 – Stock

♦ CUSTOM PRINT PROGRAM MIN:
50,000 pcs.

Material: Clear Smooth LDPE

Description: Wicketed

Size: 9" x 13" + 4" + 1.5"

Case Pack: 1,000/case

Dim: 15.5" x 10" x 2.8" – Wgt: 9.48 lbs.

Cube: 0.25 – TI/Hi: 12/17

UPC: 838702007863



9" x 15" + 5" + 1.5" LD Poly Bag

336950003 – Stock

♦ CUSTOM PRINT PROGRAM MIN:
50,000 pcs.

Material: Clear Smooth LDPE

Description: Wicketed

Size: 9" x 15" + 5" + 1.5"

Case Pack: 1,000/case

Dim: 17.8" x 10" x 3.5" – Wgt: 12.8 lbs.

Cube: 0.36 – TI/Hi: 10/13

UPC: 838702006033



9" x 18" + 4" + 1.5"

LD Bakery Bag

341118160 – Stock

♦ CUSTOM PRINT PROGRAM MIN:
50,000 pcs.

Material: High Clarity LLDPE

Description: Wicketed

Size: 9" x 18" + 4" + 1.5"

Case Pack: 1,000/case

Dim: 20.7" x 10.2" x 2.7" – Wgt: 11.2 lbs.

Cube: 0.33 – TI/Hi: 08/17

UPC: 842644054311



CLEAR WICKET BOTTOM GUSSET

10" x 15" + 4" + 1.5" LD Poly Bag

335277334 – Stock

♦ CUSTOM PRINT PROGRAM MIN:
50,000 pcs.

Material: Clear Smooth LDPE

Description: Wicketed

Size: 10" x 15" + 4" + 1.5"

Case Pack: 1,500/case

Dim: 18" x 11.3" x 5.3" – Wgt: 22.19 lbs.

Cube: 0.62 – TI/Hi: 08/08

UPC: 842644018665



10" x 17" + 4" + 1.5" LD Poly Bag

339400100 – Stock

♦ CUSTOM PRINT PROGRAM MIN:
50,000 pcs.

Material: Clear Smooth LDPE

Description: Wicketed

Size: 10" x 17" + 4" + 1.5"

Case Pack: 1,000/case

Dim: 19.5" x 10.7" x 3.1" – Wgt: 13 lbs.

Cube: 0.37 – TI/Hi: 08/15

UPC: 838702007856



10" x 19" + 4" + 1.5" LD Poly Bag

339000100 – Stock

♦ CUSTOM PRINT PROGRAM MIN:
50,000 pcs.

Material: Clear Smooth LDPE

Description: Wicketed

Size: 10" x 19" + 4" + 1.5"

Case Pack: 1,000/case

Dim: 12" x 11.1" x 5" – Wgt: 14.6 lbs.

Cube: 0.39 – TI/Hi: 12/09

UPC: 838702007818



11" x 13.5" + 3" + 1.5"

LD Poly Bag

340061071 – Stock

♦ CUSTOM PRINT PROGRAM MIN:
50,000 pcs.

Material: Clear LDPE w/ EVA

Description: Wicketed

Size: 11" x 13.5" + 3" + 1.5"

Case Pack: 1,000/case

Dim: 16.1" x 12.1" x 2.8" – Wgt: 9.7 lbs.

Cube: 0.32 – TI/Hi: 10/16

UPC: 842644055998



CLEAR WICKET BOTTOM GUSSET

11" x 14" + 4" + 1.5" LD Poly Bag

339300100 – Stock

♦ CUSTOM PRINT PROGRAM MIN:
50,000 pcs.

Material: Clear Smooth LDPE

Description: Wicketed

Size: 11" x 14" + 4" + 1.5"

Case Pack: 1,000/case

Dim: 16.9" x 11.4" x 2.8" – Wgt: 11.68 lbs.

Cube: 0.31 – TI/Hi: 08/16

UPC: 838702007849



11" x 15" + 4" + 1.5" LD Poly Bag

334350003 – Stock

♦ CUSTOM PRINT PROGRAM MIN:
50,000 pcs.

Material: Clear Smooth LDPE

Description: Wicketed

Size: 11" x 15" + 4" + 1.5"

Case Pack: 2,000/case

Dim: 18.1" x 11.4" x 6.7" – Wgt: 29.1 lbs.

Cube: 0.80 – TI/Hi: 08/07

UPC: 838702006019



11" x 17" + 4" + 1.5" LD Poly Bag

339100103 – Make & Ship

♦ CUSTOM PRINT PROGRAM MIN:
50,000 pcs.

Material: Clear Smooth LDPE

Description: Wicketed

Size: 11" x 17" + 4" + 1.5"

Case Pack: 2,000/case

Dim: 20.2" x 12.1" x 6.3" – Wgt: 35.4 lbs.

Cube: 0.89 – TI/Hi: 08/07

UPC: 838702007825



11" x 17" + 4" + 1.5" LD Bag

343830275 – Stock

♦ CUSTOM PRINT PROGRAM MIN:
50,000 pcs.

Material: Clear LDPE w/ EVA

Description: Wicketed

Size: 11" x 17" + 4" + 1.5"

Case Pack: 1,000/case

Dim: 19.7" x 12.1" x 2.8" – Wgt: 12.4 lbs.

Cube: 0.39 – TI/Hi: 08/16

UPC: 842644056001



CLEAR WICKET BOTTOM GUSSET

11" x 18" + 4" + 1.5" LD Poly Bag

339200100 – Stock

♦ CUSTOM PRINT PROGRAM MIN:
50,000 pcs.

Material: Clear Smooth LDPE

Description: Wicketed

Size: 11" x 18" + 4" + 1.5"

Case Pack: 1,000/case

Dim: 21.7" x 12.1" x 3.5" – Wgt: 15.4 lbs.

Cube: 0.53 – TI/Hi: 06/13

UPC: 838702007832



11" x 18" + 6" + 1.5" LD Poly Bag

336377406 – Stock

♦ CUSTOM PRINT PROGRAM MIN:
50,000 pcs.

Material: Clear Smooth LDPE

Description: Wicketed

Size: 11" x 18" + 6" + 1.5"

Case Pack: 1,000/case

Dim: 21.6" x 12.1" x 4.5" – Wgt: 23.6 lbs.

Cube: 0.68 – TI/Hi: 06/10

UPC: 842644018658



12" x 13.5" + 3" + 1.5" LD Poly Bag

345365420 – Make & Ship

♦ CUSTOM PRINT PROGRAM MIN:
50,000 pcs.

Material: Clear Smooth LDPE

Description: Wicketed

Size: 12" x 13.5" + 3" + 1.5"

Case Pack: 1,000/case

Dim: 15.7" x 12.2" x 2.6" – Wgt: 10.36 lbs.

Cube: 0.29 – TI/Hi: 10/18

UPC: 842644049492



14.5" x 20" + 4" + 1.5" LD Bag

336900104 – Stock

♦ CUSTOM PRINT PROGRAM MIN:
50,000 pcs.

Material: Clear Smooth LDPE

Description: Wicketed

Size: 14.5" x 20" + 4" + 1.5"

Case Pack: 1,000/case

Dim: 15.7" x 12.2" x 6.9" – Wgt: 28.7 lbs.

Cube: 0.76 – TI/Hi: 10/06

UPC: 842644003630



CLEAR WICKET FLAT

14" x 20" + 0" + 1.5"

LD Produce Bag

337382644 – Stock

♦ **CUSTOM PRINT PROGRAM MIN:**

50,000 pcs.

Material: Clear Smooth LDPE

Description: Wicketed, Carboard 2 Sides

Size: 14" x 20" + 0" + 1.5"

Case Pack: 1,000/case

Dim: 15.4" x 12.2" x 4.3" – Wgt: 20.06 lbs.

Cube: 0.47 – TI/Hi: 10/10

UPC: 842644008161



14" x 20" + 0" + 1.5" LD Poly Bag

336400103 – Stock

♦ **CUSTOM PRINT PROGRAM MIN:**

50,000 pcs.

Material: Clear Smooth LDPE

Description: Wicketed

Size: 14" x 20" + 0" + 1.5"

Case Pack: 500/case

Dim: 14.5" x 12.7" x 3" – Wgt: 12 lbs.

Cube: 0.32 – TI/Hi: 09/15

UPC: 838702007788



11.5" x 16.5" + 1.5" LD Poly Bag

341439597 – Stock

♦ **CUSTOM PRINT PROGRAM MIN:**

50,000 pcs.

Material: Clear Smooth LDPE

Description: Wicketed 5"OC

Size: 11.5" x 16.5" + 1.5"

Case Pack: 1,000/case

Dim: 18.7" x 12.2" x 2.2" – Wgt: 10.4 lbs.

Cube: 0.29 – TI/Hi: 08/21

UPC: 842644057343



CLEAR SIDE GUSSET

4" x 2" x 12" LD Poly Bag

325500109 – Stock

♦ **CUSTOM PRINT PROGRAM MIN:**

50,000 pcs.

Material: Clear Smooth LDPE

Description: Loose

Size: 4" x 2" x 12"

Case Pack: 1,000/case

Dim: 9.1" x 7.2" x 3.2" – Wgt: 3.6 lbs.

Cube: 0.12 – TI/Hi: 28/14

UPC: 838702007641



CLEAR SIDE GUSSET

4" x 2" x 12" LD Poly Bag

325500105 – Stock

♦ **CUSTOM PRINT PROGRAM MIN:**

50,000 pcs.

Material: Clear Smooth LDPE

Description: Loose

Size: 4" x 2" x 12"

Case Pack: 1,000/case

Dim: 14" x 7.2" x 5.2" – Wgt: 9.48 lbs.

Cube: 0.30 – TI/Hi: 15/09

UPC: 838702007634



5" x 4" x 15" LD Poly Bag

325800109 – Stock

♦ **CUSTOM PRINT PROGRAM MIN:**

50,000 pcs.

Material: Clear Smooth LDPE

Description: Loose

Size: 5" x 4" x 15"

Case Pack: 1,000/case

Dim: 10.7" x 9.1" x 3.2" – Wgt: 6.8 lbs.

Cube: 0.18 – TI/Hi: 18/14

UPC: 838702007689



5" x 4" x 15" LD Poly Bag

325800100 – Stock

♦ **CUSTOM PRINT PROGRAM MIN:**

50,000 pcs.

Material: Clear Smooth LDPE

Description: Loose

Size: 5" x 4" x 15"

Case Pack: 1,000/case

Dim: 11.2" x 8.3" x 4.2" – Wgt: 8.6 lbs.

Cube: 0.23 – TI/Hi: 15/11

UPC: 838702007672



5" x 4" x 18" LD Poly Bag

325700109 – Stock

♦ **CUSTOM PRINT PROGRAM MIN:**

50,000 pcs.

Material: Clear Smooth LDPE

Description: Loose

Size: 5" x 4" x 18"

Case Pack: 1,000/case

Dim: 11.5" x 9.8" x 3.2" – Wgt: 7.49 lbs.

Cube: 0.21 – TI/Hi: 16/14

UPC: 838702007665



CLEAR SIDE GUSSET

5.125" x 3.5" x 14" LD Poly Bag

326950002 – Stock

♦ **CUSTOM PRINT PROGRAM MIN:**

50,000 pcs.

Material: Clear Smooth LDPE

Description: Loose Pack, Vented

Size: 5.125" x 3.5" x 14"

Case Pack: 500/case

Dim: 7.8" x 6" x 4.3" – Wgt: 3.8 lbs.

Cube: 0.12 – TI/Hi: 40/10

UPC: 838702005999



5.25" x 3.25" x 10" LD Poly Bag

326981000 – Stock

♦ **CUSTOM PRINT PROGRAM MIN:**

50,000 pcs.

Material: Clear Smooth LDPE

Description: Dispensor Pack

Size: 5.25" x 3.25" x 10"

Case Pack: 2,000/case

Dim: 12.6" x 11.6" x 7.7" – Wgt: 11.33 lbs.

Cube: 0.65 – TI/Hi: 12/06

UPC: 838702007429



5.5" x 3" x 24" LD Poly Bag

326100109 – Stock

♦ **CUSTOM PRINT PROGRAM MIN:**

50,000 pcs.

Material: Clear Smooth LDPE

Description: Loose

Size: 5.5" x 3" x 24"

Case Pack: 1,000/case

Dim: 13" x 9.7" x 5.3" – Wgt: 10.58 lbs.

Cube: 0.39 – TI/Hi: 15/08

UPC: 838702007719



5.5" x 3" x 29" LD Poly Bag

325100109 – Stock

♦ **CUSTOM PRINT PROGRAM MIN:**

50,000 pcs.

Material: Clear Smooth LDPE

Description: Loose

Size: 5.5" x 3" x 29"

Case Pack: 1,000/case

Dim: 12.8" x 11.2" x 4.8" – Wgt: 12.1 lbs.

Cube: 0.40 – TI/Hi: 12/09

UPC: 838702007603



CLEAR SIDE GUSSET

5.5" x 3" x 29" LD Poly Bag

325100100 – Stock

♦ **CUSTOM PRINT PROGRAM MIN:**

50,000 pcs.

Material: Clear Smooth LDPE

Description: Loose

Size: 5.5" x 3" x 29"

Case Pack: 1,000/case

Dim: 13" x 11" x 6.1" – Wgt: 15.87 lbs.

Cube: 0.50 – TI/Hi: 12/07

UPC: 838702007597



5.5" x 4.5" x 16" LD Poly Bag

325000102 – Stock

♦ **CUSTOM PRINT PROGRAM MIN:**

50,000 pcs.

Material: Clear Smooth LDPE

Description: Loose

Size: 5.5" x 4.5" x 16"

Case Pack: 1,000/case

Dim: 12.8" x 9.3" x 3.8" – Wgt: 10 lbs.

Cube: 0.26 – TI/Hi: 15/12

UPC: 838702007580



5.5" x 4.75" x 19" LD Poly Bag

324400109 – Stock

♦ **CUSTOM PRINT PROGRAM MIN:**

50,000 pcs.

Material: Clear Smooth LDPE

Description: Loose Pack

Size: 5.5" x 4.75" x 19"

Case Pack: 1,000/case

Dim: 12.8" x 7.6" x 4.6" – Wgt: 9.6 lbs.

Cube: 0.26 – TI/Hi: 19/10

UPC: 838702007511



6" x 3" x 15" LD Poly Bag

324700105 – Stock

♦ **CUSTOM PRINT PROGRAM MIN:**

50,000 pcs.

Material: Clear Smooth LDPE

Description: Loose

Size: 6" x 3" x 15"

Case Pack: 1,000/case

Dim: 13.2" x 8.5" x 7.1" – Wgt: 16.6 lbs.

Cube: 0.46 – TI/Hi: 16/06

UPC: 838702007566



CLEAR SIDE GUSSET

6" x 3" x 15" LD Poly Bag
324700108 – Stock

♦ **CUSTOM PRINT PROGRAM MIN:**
50,000 pcs.

Material: Clear Smooth LDPE
Description: Loose Pack
Size: 6" x 3" x 15"
Case Pack: 500/case
Dim: 13.4" x 8.5" x 3.2" – Wgt: 6.8 lbs.
Cube: 0.21 – TI/Hi: 16/15
UPC: 838702007573



6" x 3.5" x 18" LD Poly Bag
326950001 – Stock

♦ **CUSTOM PRINT PROGRAM MIN:**
50,000 pcs.

Material: Clear Smooth LDPE
Description: Loose Pack, Vented
Size: 6" x 3.5" x 18"
Case Pack: 500/case
Dim: 9.8" x 6.7" x 3.9" – Wgt: 5.51 lbs.
Cube: 0.15 – TI/Hi: 28/12
UPC: 838702005982



8" x 3" x 15" LD Poly Bag
324200109 – Stock

♦ **CUSTOM PRINT PROGRAM MIN:**
50,000 pcs.

Material: Clear Smooth LDPE
Description: Loose Pack
Size: 8" x 3" x 15"
Case Pack: 1,000/case
Dim: 16.9" x 8.7" x 2.8" – Wgt: 8.16 lbs.
Cube: 0.24 – TI/Hi: 10/16
UPC: 838702007504



8" x 4" x 18" LD Poly Bag
324600109 – Stock

♦ **CUSTOM PRINT PROGRAM MIN:**
50,000 pcs.

Material: Clear Smooth LDPE
Description: Loose Pack
Size: 8" x 4" x 18"
Case Pack: 1,000/case
Dim: 16.9" x 9.6" x 3.1" – Wgt: 10.6 lbs.
Cube: 0.29 – TI/Hi: 10/14
UPC: 838702007559



CLEAR SIDE GUSSET

8" x 4" x 18" LD Poly Bag
328857296 – Stock

♦ **CUSTOM PRINT PROGRAM MIN:**
50,000 pcs.

Material: Clear Smooth LDPE
Description: Loose Pack
Size: 8" x 4" x 18"
Case Pack: 1,000/case
Dim: 17.2" x 9.6" x 3.1" – Wgt: 11.20 lbs.
Cube: 0.30 – TI/Hi: 10/14
UPC: 842644011680



8" x 4" x 18" LD Poly Bag
324600108 – Stock

♦ **CUSTOM PRINT PROGRAM MIN:**
50,000 pcs.

Material: Clear Smooth LDPE
Description: Loose Pack
Size: 8" x 4" x 18"
Case Pack: 1,000/case
Dim: 17" x 9.7" x 6.6" – Wgt: 22.6 lbs.
Cube: 0.63 – TI/Hi: 10/07
UPC: 838702007542



8" x 4" x 18" LD Poly Bag
324600105 – Stock

♦ **CUSTOM PRINT PROGRAM MIN:**
50,000 pcs.

Material: Clear Smooth LDPE
Description: Loose Pack
Size: 8" x 4" x 18"
Case Pack: 500/case
Dim: 17" x 9.8" x 3.8" – Wgt: 13.8 lbs.
Cube: 0.37 – TI/Hi: 10/12
UPC: 838702007535



8.25" x 3.25" x 20" LD Poly Bag
326950003 – Stock

♦ **CUSTOM PRINT PROGRAM MIN:**
50,000 pcs.

Material: Clear Smooth LDPE
Description: Loose Pack, Vented
Size: 8.25" x 3.25" x 20"
Case Pack: 200/case
Dim: 8.5" x 7.5" x 2.8" – Wgt: 3.09 lbs.
Cube: 0.10 – TI/Hi: 28/17
UPC: 838702006002



CLEAR SIDE GUSSET

10" x 4" x 20" LD Poly Bag
325200105 – Stock

♦ **CUSTOM PRINT PROGRAM MIN:**
50,000 pcs.

Material: Clear Smooth LDPE
Description: Loose Pack
Size: 10" x 4" x 20"
Case Pack: 500/case
Dim: 15.3" x 11.3" x 6.1" – Wgt: 18.2 lbs.
Cube: 0.61 – TI/Hi: 10/07
UPC: 838702007610



10" x 8" x 24" LD Poly Bag
326000109 – Stock

♦ **CUSTOM PRINT PROGRAM MIN:**
50,000 pcs.

Material: Clear Smooth LDPE
Description: Loose Pack
Size: 10" x 8" x 24"
Case Pack: 500/case
Dim: 17.2" x 10.7" x 2.7" – Wgt: 10.14 lbs.
Cube: 0.29 – TI/Hi: 09/17
UPC: 838702007702



10" x 8" x 24" LD Poly Bag
325852657 – Stock

♦ **CUSTOM PRINT PROGRAM MIN:**
50,000 pcs.

Material: Clear Smooth LDPE
Description: Loose Pack
Size: 10" x 8" x 24"
Case Pack: 500/case
Dim: 13" x 11" x 6.6" – Wgt: 21.8 lbs.
Cube: 0.55 – TI/Hi: 12/07
UPC: 842644010959



10" x 8" x 26" LD Poly Bag
325400108 – Stock

♦ **CUSTOM PRINT PROGRAM MIN:**
50,000 pcs.

Material: Clear Smooth LDPE
Description: Loose Pack
Size: 10" x 8" x 26"
Case Pack: 500/case
Dim: 18.9" x 11" x 4.7" – Wgt: 23.8 lbs.
Cube: 0.57 – TI/Hi: 08/10
UPC: 838702007627



CLEAR SIDE GUSSET

12" x 6" x 24" LD Poly Bag
324500105 – Stock

♦ **CUSTOM PRINT PROGRAM MIN:**
50,000 pcs.

Material: Clear Smooth LDPE
Description: Loose Pack
Size: 12" x 6" x 24"
Case Pack: 100/case
Dim: 12.8" x 9.1" x 2.5" – Wgt: 5.6 lbs.
Cube: 0.17 – TI/Hi: 15/18
UPC: 838702007528



12" x 8" x 30" LD Poly Bag
334573349 – Stock

♦ **CUSTOM PRINT PROGRAM MIN:**
50,000 pcs.

Material: Clear Smooth LDPE
Description: Loose Pack
Size: 12" x 8" x 30"
Case Pack: 250/case
Dim: 13.5" x 11.8" x 5.7" – Wgt: 19.2 lbs.
Cube: 0.53 – TI/Hi: 12/08
UPC: 842644020132



16" x 4" x 23" LD Poly Bag
325300100 – Stock

♦ **CUSTOM PRINT PROGRAM MIN:**
50,000 pcs.

Material: Clear Smooth LDPE
Description: Loose Pack
Size: 16" x 4" x 23"
Case Pack: 500/case
Dim: 16.5" x 12.7" x 3" – Wgt: 15.33 lbs.
Cube: 0.36 – TI/Hi: 08/15
UPC: 838702007894



18" x 7" x 24.5" Party Tray Bag
343700100 – Stock

♦ **CUSTOM PRINT PROGRAM MIN:**
50,000 pcs.



Material: Clear Smooth LDPE
Description: Dual Gusset, Die Cut Handle
Size: 18.9" x 13" x 2"
Case Pack: 50/case
Dim: 18.9" x 13" x 2" – Wgt: 4.6 lbs.
Cube: 0.29 – TI/Hi: 07/23
UPC: 842644006297







- ◆ Choose from beer, wine, cup, and juice bottle carriers
- ◆ All carriers are designed for ease of use
- ◆ Handled carriers for grab and go convenience
- ◆ **CUSTOM PRINT PROGRAM:** Customize eligible items with your brand and design (up to 4 spot colors)*
 - * Stock Non-Woven PP Wine Carrier colors include white, black, blue and green
 - * Custom bag colors available with a minimum order of 20,000 pcs.
- ◆ Low minimum custom print runs with 12 week lead time from receipt of approved artwork

 Hot Food Friendly
 Cold Food Friendly

 Leak Resistant
 Certified Biodegradable

 Custom Printing
 Reusable Item

 Recyclable Item*
* If clean and dry
 Recyclability varies by item type

CORRUGATED BEER & WINE CARRIERS



Corrugated Beer Carrier

096554618 – Stock

♦ **CUSTOM PRINT PROGRAM MIN: 5,000 pcs.**

Material: Corrugate

Description: Beer Holder, Prebuilt, 1CF/1CB

Size: 8" x 5.25" x 8.25" x 8.5"

Case Pack: 75/case

Dim: 24.5" x 13.6" x 9" – Wgt: 14.8 lbs.

Cube: 1.74 – TI/Hi: 06/05

UPC: 842644028053



Corrugated Wine Carrier

097199598 – Stock

♦ **CUSTOM PRINT PROGRAM MIN: 5,000 pcs.**

Material: Corrugate

Description: Wine Holder, Prebuilt, 1CF/1CB

Size: 10.5" x 7" x 12"

Case Pack: 50/case

Dim: 18.7" x 12.6" x 14.6" – Wgt: 16.6 lbs.

Cube: 1.99 – TI/Hi: 07/03

UPC: 842644028060



reBAG™ WINE CARRIER



Wine Carrier reBag™

532537257 – Stock

♦ **CUSTOM PRINT PROGRAM MIN: 2,000 pcs.**

w/Stock Bag Color

Material: Wine Holde, Non-Woven PP

Description: reBag, 2CF/2CB

Size: 10" x 6.5" x 11" x 6.5"

Case Pack: 50/case

Dim: 11.8" x 11" x 19.6" – Wgt: 8.2 lbs.

Cube: 1.47 – TI/Hi: 08/04

UPC: 842644011116



PAPERBOARD DRINK CARRIERS



Molded Paper Drink Carrier

008988808 – Stock

Capacity: 4 - 32 oz. Drinks

Material: Pulp

Description: 4 Drink Carrier, Natural

Size: 8.74" x 8.74" x 2.17"

Case Pack: 300/case

Dim: 26.6" x 18.2" x 9.1" – Wgt: 21.83 lbs.

Cube: 2.55 – TI/Hi: 03/05

UPC: 842644074623



4-Cup Drink Carrier

018706050 – Stock

Capacity: 4 - 32 oz. Drinks

Material: Kraft

Description: Drink Carrier, Prebuilt, Plain

Size: 6.75" x 6.75" x 8"

Case Pack: 250/case

Dim: 23" x 8.5" x 13.5" – Wgt: 28 lbs.

Cube: 1.53 – TI/Hi: 09/03

UPC: 10850191008968



4-Pack Beverage Carrier

017655698 – Stock

Capacity: 4 - 16 oz. Juice Bottles

Material: CCSUS

Description: Bottle Carrier, Prebuilt, Plain

Size: 5" x 5" x 7.187"

Case Pack: 200/case

Dim: 20.4" x 7.8" x 10.8" – Wgt: 17.8 lbs.

Cube: 0.99 – TI/Hi: 12/04

UPC: 842644066260



GALLONPAK DRINK DISPENSER



GallonPak Drink Dispenser

294601555 – Stock

♦ **CUSTOM PRINT PROGRAM MIN: 15,000 pcs.**

Capacity: 128 Fluid oz.

Material: Clear PET/NY/PE

Description: Gallon Beverage Pouch

Size: 12" x 12.8" x 5.7"

Case Pack: 25/case

Dim: 19.7" x 14.1" x 4" – Wgt: 4 lbs.

Cube: 0.64 – TI/Hi: 06/11

UPC: 842644052416





- ◆ Drawstring options for quick and easy closure
- ◆ 8, 10, and 20 lb. bags.
- ◆ **CUSTOM PRINT PROGRAM:** Customize eligible items with your brand and design (up to 10 colors)
- ◆ Low minimum custom print runs with 12 week lead time from receipt of approved artwork

 Cold Food Friendly

 Custom Printing

 Recyclable Item*
*If clean and dry
Check with your local municipality/store

ICE BAGS



8 lb. Drawstring Ice Bag

368309990 – Stock

♦ **CUSTOM PRINT PROGRAM MIN: 50,000**

Material: LDPE+EVA

Description: Polar Bear Design, Loose Pack

Size: 12" x 18"

Case Pack: 500/case

Dim: 18.6" x 13" x 4.7" – Wgt: 14.4 lbs.

Cube: 0.66 – TI/Hi: 09/08

UPC: 842644026066



10 lb. Drawstring Ice Bag

367706872 – Stock

♦ **CUSTOM PRINT PROGRAM MIN: 50,000**

Material: LDPE+EVA

Description: Polar Bear Design, Loose Pack

Size: 12" x 20"

Case Pack: 500/case

Dim: 20.3" x 13.1" x 4.5" – Wgt: 16.6 lbs.

Cube: 0.69 – TI/Hi: 08/08

UPC: 842644026073



20 lb. Drawstring Ice Bag

361802715 – Stock

♦ **CUSTOM PRINT PROGRAM MIN: 50,000**

Material: LDPE+EVA

Description: Polar Bear Design, Loose Pack

Size: 14" x 26"

Case Pack: 250/case

Dim: 19.2" x 15.3" x 3.6" – Wgt: 16.6 lbs.

Cube: 0.61 – TI/Hi: 06/12

UPC: 842644026080



ICE BAGS



8 lb. Loose Pack Ice Bag

367393021 – Stock

♦ **CUSTOM PRINT PROGRAM MIN: 50,000**

Material: LDPE

Description: Polar Bear Design, Loose Pack

Size: 12" x 18"

Case Pack: 1,000/case

Dim: 21" x 11.7" x 4.1" – Wgt: 22.8 lbs.

Cube: 0.58 – TI/Hi: 07/10

UPC: 842644031374



10 lb. Loose Pack Ice Bag

360515791 – Stock

♦ **CUSTOM PRINT PROGRAM MIN: 50,000**

Material: LDPE

Description: Polar Bear Design, Loose Pack

Size: 12" x 20"

Case Pack: 1,000/case

Dim: 24.2" x 12.2" x 5" – Wgt: 26 lbs.

Cube: 0.85 – TI/Hi: 06/07

UPC: 842644031367



20 lb. Loose Pack Ice Bag

363840048 – Stock

♦ **CUSTOM PRINT PROGRAM MIN: 50,000**

Material: LDPE+EVA

Description: Polar Bear Design, Loose Pack

Size: 14" x 26"

Case Pack: 500/case

Dim: 15" x 15.2" x 4.9" – Wgt: 25.79 lbs.

Cube: 0.65 – TI/Hi: 06/09

UPC: 842644026837





INNOVATIVE IDEAS



- ◆ reBags™ are strong and hold up to 35 pounds
- ◆ Insulated and non-insulated bags available
- ◆ Available with full or reduced handles
- ◆ Stock bag colors include white, black, blue and green
- ◆ **CUSTOM PRINT PROGRAM:** Customize eligible items with your brand and design (up to 6 colors)
- ◆ Low minimum custom print runs with 12 week lead time from receipt of approved artwork

 Hot Food Friendly

 Leak Resistant

 Custom Printing

 Reusable Item

 Cold Food Friendly

reBAG™ BAGS



Everyday reBag™

531277851 – Stock

- ♦ CUSTOM PRINT PROGRAM MIN: 2,000 pcs. w/Stock Bag Color
- ♦ CUSTOM PRINT PROGRAM MIN: 10,000 pcs. w/Custom Bag Color

Material: Non-Woven PP

Description: Green, reBag™, Full Handle, 2CF/2CB

Size: 12.75" x 8.5" x 13.25" x 8.5"

Case Pack: 50/case

Dim: 14.2" x 13.2" x 11.6" – Wgt: 10.6 lbs.

Cube: 1.26 – TI/Hi: 09/04

UPC: 842644012939



Thermal reBag™

535399360 – Stock

- ♦ CUSTOM PRINT PROGRAM MIN: 2,000 pcs. w/Stock Bag Color
- ♦ CUSTOM PRINT PROGRAM MIN: 10,000 pcs. w/Custom Bag Color

Material: Non-Woven PP, Foil Lined

Description: Blue, reBag™, 2CF/2CB

Size: 13" x 8" x 14" x 8"

Case Pack: 25/case

Dim: 14.6" x 13.8" x 16.7" – Wgt: 7.2 lbs.

Cube: 1.95 – TI/Hi: 06/02

UPC: 842644014094



reBAG™ BAGS



Insulated Cooler reBag™

536827082 – Stock

- ♦ CUSTOM PRINT PROGRAM MIN: 2,000 pcs. w/Stock Bag Color
- ♦ CUSTOM PRINT PROGRAM MIN: 10,000 pcs. w/Custom Bag Color

Material: Non-Woven PP, Plastic Lined

Description: Blue, reBag™, Reduced Handle, 2CF/2CB

Size: 13" x 8" x 14" x 8"

Case Pack: 25/case

Dim: 14.6" x 13.8" x 16.7" – Wgt: 7.72 lbs.

Cube: 1.95 – TI/Hi: 06/02

UPC: 842644019082



CUSTOM NON-WOVEN LAMINATED TOTES

MAKE A STATEMENT AN UPSCALE REBAG™

- ♦ Fully customize with your brand or design
- ♦ Stunning print capabilities to maximize visual impact
- ♦ Choose your handle and piping color
- ♦ Reusable, sturdy, and durable



Call your Inno-Pak sales representative for more information or to place an order.



CORRUGATED CARRYOUT CARTONS



- ◆ Convenient way to package and transport large carryout meals
- ◆ Sturdy corrugate designs
- ◆ Carry handles
- ◆ Holiday Box has locking corners to prevent accidental opening and fits whole turkeys, hams, and half-pans
- ◆ Catering Box is a tuck top, stackable, and fits up to 3 full pans

- Hot Food Friendly
- Cold Food Friendly
- Recyclable Item*
* If clean and dry

CORRUGATED CARRYOUT CARTONS



Corrugated Holiday Box
090802310 – Stock
 Material: Single Wall Corrugate
 Description: Gabled Handle
 Size: 14.25" x 11" x 9"
 Case Pack: 25/case
 Dim: 25.7" x 19.5" x 9.5" – Wgt: 22 lbs.
 Cube: 2.76 – TI/Hi: 03/05
 UPC: 842644044862



Corrugated Catering Box
091235712 – Stock
 Material: Single Wall Corrugate
 Description: Side Handles, Tuck Top, Auto Bottom
 Size: 21" x 14" x 12.125"
 Case Pack: 15/case
 Dim: 34.8" x 28.8" x 6" – Wgt: 31 lbs.
 Cube: 3.48 – TI/Hi: 02/05
 UPC: 842644046517



INNOVATION REQUIRES WORLD-CLASS FACILITIES



Who We Are:

At Inno-Pak, we want innovation to impact every customer touch point and experience with our company. From our web-based inventory and warehousing software solutions to the one-of-a-kind designs that drive our success, we make sure innovation is at the heart of everything we do. Whether it's researching the newest art and packaging trends or tracking orders in real time, we constantly strive to bring you the best, most innovative packaging solutions in the industry.

The Early Days: Our past is rooted in hard work and innovation. Founded in 1992 in a basement office with a folding table as a desk, Inno-Pak was customer-focused from the beginning. From there, we developed strategic partnerships and programs that helped the company grow and thrive, an approach that still guides us today.

A Global Leader: From the beginning, innovation guided our business philosophy, and it will continue to drive our actions in the years to come. Inno-Pak has emerged as a global leader with a broad product offering and ownership/joint ventures in both the United States and Asia, yet we remain nimble, proactive and focused on customers – not shareholders.

State-of-the-Art Warehousing:

This is another area where innovation takes center stage at Inno-Pak. Our new 315,000-square-foot distribution and warehouse facility near Columbus, Ohio is carefully synced with our web-based software to save time and increase efficiency. That means workers in the corporate office and workers in the warehouse have access to the same information about the status of every order. Best of all, our customers have access to real-time tracking capabilities whenever and wherever they need it.



Global Manufacturing

In today's competitive marketplace, it would be difficult to overstate the advantages of global manufacturing. That's why Inno-Pak is well positioned with production facilities in the United States, Malaysia, China and India, and corporate offices in Ohio, Texas and Shanghai, China. Today, our global footprint is a game-changer when it comes to providing our customers with cost-effective packaging solutions. Each packaging solution is produced and shipped from one of our domestic or global facilities to our state-of-the-art distribution center for just-in-time delivery to you.



INNOVATION STARTS WITH EXCEPTIONAL DESIGN

Structural Design

Our lead engineer leverages a state-of-the-art software and hardware suite along with decades of experience to tailor solutions to your needs. In addition, we're constantly applying new techniques, tools, and sustainable, environmentally friendly materials to ensure our work remains best in class. Whether you need packaging made from paperboard, plastic, or corrugate, we can make it happen.

Graphic Design

Our creative team has extensive experience designing for everyone from single-unit operators to Fortune 500 companies. We are continuously refining our techniques to stay on top of design and industry trends, and our state-of-the-art tools allow us to bring your creative vision to life. This talented team is passionate about providing high-quality design solutions and service to all of our customers.

What We Do

We innovate.

We continually develop and innovate efficient, creative solutions for our customers.

We engineer.

We tailor the structural design to ensure the packaging meets the need.

We get involved.

We attend shows and conferences to stay current on technologies and trends.

We create.

We are proactive thinkers who devise creative solutions for all types of packaging.

We support.

We support our customers by ensuring they receive the design solution they need.

We stay current.

We research trends and pay attention to what's happening in the marketplace.

Structural Design Meets Graphic Design

We provide a full range of design services:

◆ Concepting
Structural & Creative

◆ Design
Structural & Creative

◆ Production
Creative

Print Processes:

◆ Offset
Up to 6 & 8 colors

◆ Rotogravure
Up to 10 colors

◆ Flexographic
Up to 4,5, & 10 colors

The Creation Process:

Step 1: We gather information, review specs, and create structural options to pick from.

Step 2: Once a concept is chosen, the structure is refined based on feedback.

Step 3: Upon structure approval, the creative team begins art concepts.

Step 4: Creative uses all direction and design trends to produce art concepts.

Step 5: Once an art concept is chosen, the design is refined based on feedback.

Step 6: Upon art approval, the design is prepared for release to our plant.

ECO-RESPONSIBILITY & SUSTAINABILITY

At Inno-Pak, we take the environment and our impact on it very seriously. As a SPC and How2Recycle member, we are working to make as much of the packaging we provide either recyclable, reusable, compostable, or a combination of all three categories. We also offer alternatives to popular products that reduce case size and case packs leading to fewer shipments and a smaller warehousing footprint.



Compostable Packaging



Recyclable Packaging



Reusable Packaging

CHALLENGE US!

At Inno-Pak, we love a good challenge.

When others say it can't be done, that's our cue to accept the challenge. No challenge is too big for our talented team. We can design and manufacture a custom solution addressing your graphic and structural needs - without sacrificing cost-effectiveness. Choose from one of our many innovative packaging solutions, or share your vision, and let us help you bring it to life.



1932 Pittsburgh Drive, Delaware, OH 43015
1.800.INNOPAK • www.innopak.com