



Global Foodservice Equipment Catalog



## Over 100 years of commercial expertise

Since 1911, businesses have relied on Hamilton Beach Commercial® for top-performing, durable equipment. From innovative, high-performance blenders to vacuum packaging machines, we have everything you need to keep your business running smoothly, whether you operate a single restaurant, bar, or manage a chain.

Hamilton Beach Commercial® has a proud history of designing products with the end user in mind, focusing on quality, durability, and innovation. Another key to our customer-centric process is to support you with exceptional service every step of the way. Think of Hamilton Beach Commercial® as partners in your business — we go out of our way to ensure your satisfaction.

### Beverage Prep

2-3	Bar Blenders
4-5	High-Performance Blenders
6-7	Beverage Automation
8-9	Drink Mixers
10-11	Coffee Urns

### Food Prep

12-13	Expeditor™ Culinary Blenders
14-15	Back-of-the-House Equipment
16-17	Immersion Blenders / BigRig™
18-19	FreshMark™ Juicers
20-22	PrimaVac™ Vacuum Packaging

### Accessories

24-27	Supplies and Parts
-------	--------------------

# Bar Blenders

Powering the front of the house

## HBB908R Series



HBB908R (120 V)

HBB908R (230 V)

### 908® Blender

1 peak\* HP motor

**Blend Drinks in 25 Seconds** – Perfect for operations that serve 1-25 drinks daily.

**Wave~Action® System** – Unique container design continually forces mixture down into blades for a super-creamy drink profile every time.

**Two Speeds** – For easy control.

**4 Durable Stainless Steel Blades** – Made to last and get the job done fast.

**44 oz./1.3 L Container** – Break-resistant polycarbonate container with easy-to-read measurement marks.

**Sure Grip™ Feet** – Hold blender securely in place.

**Lid Open Sensor** – Prevents blending with lid removed (230 V only).



**HBB908R Ship Weight (120 V and 230 V):**

8.1 lbs/ 3.68 kg

**Warranty:** 1 year parts & labor

#### 120 V Specifications:

HBB908R  
120 V~, 60 HZ, 6 A



#### 230 V Specifications:

HBB908R-CE  
HBB908R-UK  
220-240 V~, 50-60 HZ, 3 A



## HBB255 Series



HBB255 (120 V)

HBB255 (230 V)

### Rio® Blender

1.6 peak\* HP motor

**Blend Drinks in 15 Seconds** – Perfect for operations that serve 15-40 drinks daily.

**Wave~Action® System** – Unique container design continually forces mixture down into blades for a super-creamy drink profile every time.

**Optimized Performance** – Wide square jar accommodates larger ingredients, reducing prep time.

**High Performance Stainless Steel Blades** – Quickly cut through ice.

**Two Speeds with Pulse Option** – Offers versatility and precision blending for a wide variety of drinks.

**Lid Open and Jar Pad Sensor** – Prevents blending if jar or lid is not on correctly (230 V only).

**48 oz./1.4 L Container** – Break-resistant BPA-free co-polyester container.



**HBB255 (120 V) Ship Weight:** 9.5 lbs/4.3 kg

**HBB255 (230 V) Ship Weight:** 4.5 kg/9.92 lbs

**Warranty:** 2 years parts & labor

#### 120 V Specifications:

HBB255  
120 V~, 60 HZ, 6.5 A



#### 230 V Specifications:

HBB255-CE  
HBB255-UK  
HBB255-CN  
220-240 V~, 50-60 HZ, 3.2 A



**Most bar blenders are pushed to their limit on a daily basis,** so they need to be extremely durable and easy to use. These blending workhorses are built to last and can keep up with the demands of the busiest bars. All models feature intuitive controls, so bartenders can focus on blending and serving customers instead of wasting time on complicated functions.

## HBB255S Series



## ACCESSORIZE

Keep your blenders in top condition and your business running smoothly

### Rio® Blender

1.6 peak\* HP motor

**Blend Drinks in 15 Seconds** – Perfect for operations that serve 15-40 drinks daily.

**Wave~Action® System** – Unique container design continually forces mixture down into blades for a super creamy drink profile every time.

**Optimized Performance** – Wide square jar accommodates larger ingredients, reducing prep time.

**High Performance Stainless Steel Blades** – Quickly cut through ice.

**Two Speeds with Pulse Option** – Offers versatility and precision blending for a wide variety of drinks.

**Lid Open and Jar Pad Sensor** – Prevents blending if jar or lid is not on correctly (230 V only).

**32 oz./0.95 L Stainless Steel Container** – Built for long-lasting performance.



**HBB255S (120V) Ship Weight:** 9.5 lbs/4.3 kg

**HBB255S (230V) Ship Weight:** 4.7 kg/10.4 lbs

**Warranty:** 2 years parts & labor

#### 120 V Specifications:

HBB255S  
120 V~, 60 HZ, 6.5 A



#### 230 V Specifications:

HBB255S-CE  
HBB255S-UK  
HBB255S-CN  
220-240 V~, 50-60 HZ, 3.2 A



\* Input power



**6126-908R**

**44 oz./1.3 L Polycarbonate Container**

For HBB908R Series



**6126-455**

**48 oz./1.4 L BPA-Free Co-Polyester Container**

For HBB255, HBH455 and HBF510 Series (120 V)



**6126-455-CE**

**48 oz./1.4 L BPA-Free Co-Polyester Container**

For HBB255, HBH455 and HBF510 Series (230 V)



**98455**

**Cutter Assembly Jar Repair Kit**

For HBB255, HBB255S, HBH455 and HBF510 Series

Turn to page 24 for our complete selection of Bar Blender accessories

# High-Performance Blenders

Improving high-volume efficiency

## HBH455 Series



HBH455 (120 V)

HBH455 (230 V)

### Tango® Blender

2.4 peak\* HP motor

**Two Speeds and Pulse** – Offers versatility and precision blending for a wide variety of drinks.

**Wave~Action® System** – Unique container design continually forces mixture down into blades for a super creamy drink profile every time.

**Timer with Automatic Shutoff** – Indispensable for busy bars, it frees operators up for other tasks.

**48 oz./1.4 L Stackable Container** – BPA-free co-polyester container minimizes storage.

**Lid Open and Jar Pad Sensor** – Prevents blending if jar or lid is not on correctly (230 V only).

## HBH550 Series



### Fury™ Blender

3 HP motor

**Two Speeds plus Pulse** – Offer precision blending for a wide variety of drink mixtures.

**Timer with Automatic Shutoff** – Indispensable for busy bars, it frees operators up for other tasks.

**Powerful 3 HP motor** – Built with a durable all-metal drive coupling to satisfy the demands of the busiest bars.

**64 oz./1.8 L Stackable Container** – Features patented Wave~Action® system for optimal blending performance.

## HBH650 Series



### Tempest® Blender

3 HP motor

**Two Speeds, Jump Cycle, and Pulse Button** – Offer precision blending for a wide variety of drink mixtures.

**Timer with Automatic Shutoff** – Indispensable for busy bars, it frees operators up for other tasks.

**Powerful 3 HP motor** – Built with a durable all-metal drive coupling to satisfy the demands of the busiest bars.

**64 oz./1.8 L Stackable Container** – Features patented Wave~Action® system for optimal blending performance.



**HBH455 (120 V) Ship Weight:** 11.9 lbs/5.4 kg

**HBH455 (230 V) Ship Weight:** 5.6 kg/12.3 lbs

**Warranty:** 2 years parts & labor

#### 120 V Specifications:

HBH455  
120 V~, 60 HZ, 10 A



#### 230 V Specifications:

HBH455-CE  
HBH455-UK  
HBH455-CN  
220-240 V~, 50-60 HZ, 6.5 A



**Ship Weight:** 13.9 lbs/6.3 kg

**Warranty:** 3 years parts & labor  
(lifetime on motor drive coupling and blade)

#### 120 V Specifications:

HBH550  
120 V~, 60 HZ, 13 A



#### 230 V Specifications:

HBH550-CE  
HBH550-UK  
HBH550-CCC  
220-240 V~, 50-60 HZ, 880 W



**Ship Weight:** 13.9 lbs/6.3 kg

**Warranty:** 3 years parts & labor  
(lifetime on motor drive coupling and blade)

#### 120 V Specifications:

HBH650  
120 V~, 60 HZ, 13 A



#### 230 V Specifications:

HBH650-CE  
HBH650-UK  
HBH650-CCC  
220-240V~, 50-60 HZ, 880 W





**With our high-performance blenders,** it's easy to achieve optimum results every time you blend. From convenient timers with automatic shutoff to advanced one-touch cycles, they have everything you need for maximum blending control and efficiency. To reduce noise, consider one with a sound enclosure — it will provide amazing power, yet it won't interrupt conversations.

## HBH755 Series



### Eclipse™ Blender

**3 peak\* HP motor**

**QuietBlend™ Technology** – Reduces motor noise and works with the Quiet Shield™ enclosure to lower sound to a conversation level.

**Over 100 Pre-programmed Cycles** – Can be assigned to 5 buttons for popular drinks and additional cycles can be loaded via memory card.

**Sensors** – Equipped on the shield and jar pad (120 V only) to extend life and ensure quiet operation.

**Powerful 3 Peak HP Motor with Airflow Design** – Provides excellent blending results, helps prevent motor overheating, and extends motor life.

**64 oz./2 L Stackable Container** – Features patented Wave~Action® system for optimal blending performance.



**Ship Weight:** 19.8 lbs/9 kg

**Warranty:** 3 years parts & labor (lifetime on motor drive coupling and blade)

**120 V Specifications:**

HBH755  
120 V~, 60 HZ, 8.6 A



**230 V Specifications:**

HBH755-CE  
HBH755-UK  
HBH755-CN  
220-240 V~, 50-60 HZ, 1000 W



\* Input power

## HBH850 Series



### Summit® Blender

**with Auto Blend**

**Auto Blend Technology** – Stops the blender when the drink reaches the perfect consistency.

**Quiet Shield™ Enclosure** – Reduces noise.

**Over 100 Pre-programmed Cycles** – Can be assigned to 4 buttons; additional cycles can be loaded via USB.

**Sensors** – Equipped on shield (230 V only) and jar pad (120 V only) to extend life and ensure quiet operation.

**Powerful 3 HP Motor** – Features a rear airflow baffle design that helps prevent motor overheating and extends motor life.

**64 oz./1.8 L Container**



**Ship Weight:** 23.3 lbs/10.6 kg

**Warranty:** 3 years parts & labor (lifetime on motor drive coupling and blade)

**120V Specifications:**

HBH850  
120 V~, 60 HZ, 13 A



**230V Specifications:**

HBH850-CE  
HBH850-UK  
HBH850-CCC  
220-240 V~, 50-60 HZ, 880 W



## ACCESSORIZE

### 6126-751

#### AirWhip Frothing Jar

Quickly creates perfect milk foam and emulsifies dressings and sauces



Cold foam in less than 20 seconds

- Versatile 48 oz./1.4 L container for delicate blends
- Removable filler cap
- Durable jar clutch

Turn to page 25 for our complete selection of High Performance Blender jars and accessories

# Beverage Automation

Taking automation to the next level

## HBS1400 Series/HBS1200 Series



### Revolution® Ice Shaver/Blender

5 gallon / 19 L ice capacity

**Revolution® Portion System** – For maximum accuracy, the ice portioning system counts the number of times the agitator passes the shaver blade. Regardless of the motor load, the correct amount of ice comes out every time.

**Double-Wall Hopper** – Insulated for quiet operation and to keep ice cold.

**Sensor Technology** – Hopper sensor prevents operation when lid is not in place. Drain sensor indicates if water is backed up in the drain.

**Powerful 3 HP Motor** – Heavy-duty and built to satisfy the demands of the busiest bars.

**Automatic Cycle Buttons** – Lets operators select serving size and number of servings for precise results.

**64 oz./1.8 L Stackable Container with Wave-Action® System** – Provides optimal blend performance.

## BCR100

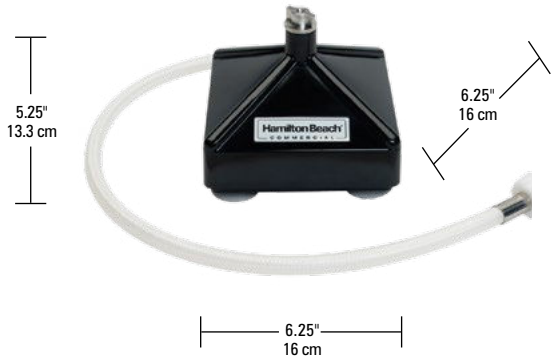

### Container Rinser

**Designed To Rinse Various Containers** – Rinses all jars, cups and containers up to 64 oz./2 L.

**Durable Construction** – Stainless steel spray nozzle; break-resistant polycarbonate.

**Easy Operation** – A gentle push on platform activates spray.

**Compact and Low Profile Design** – Fits easily in sink at 6.25"/160 mm square and 5.25"/133 mm high.

**Raised Nozzle** – For better cleaning.

**Suction Cup Feet** – Hold rinser securely in place.



**Ship Weight:** 71 lbs/32.2 kg

**Warranty:** 2 years parts & labor (lifetime on motor drive coupling and blade)

**HBS1400**

**120 V Specifications:**

120 V~, 60 HZ, 15 A



**HBS1200**

**230 V Specifications:**

HBS1200-CE  
220-240 V~, 50-60 HZ, 1000 W



Comes with CE and UK cordsets

**RoHS COMPLIANT**



**Ship Weight:** 1.2 lbs/0.5 kg

**Warranty:** 1 year parts & labor

**BCR100**

**Specifications:**

Unit comes with base, nozzle, hose. Base: break-resistant polycarbonate; with 4 suction cups. 2.5 ft./0.7 m flexible 3/8" / 10 mm (ID) reinforced tubing with swivel garden hose (GHT) fitting. No electricity required.

Flow rate: 2.25 gpm/8.521 pm@60 psi



**Whether you need a large batch of drinks or single servings by the cup,** we have the beverage automation solution that's right for you. By removing the possibility of inconsistency, these automation options are able to achieve perfection with every serving. Not only will you serve delicious drinks day after day, you'll save valuable time and labor year after year.

## BIC2000 Series

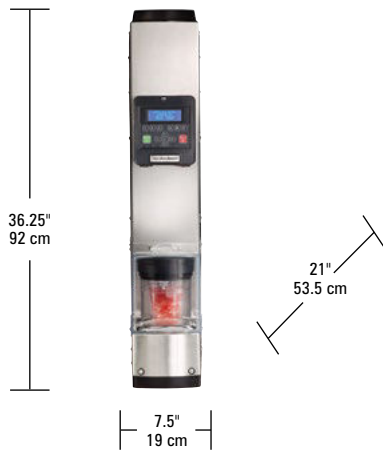

### SmartServe™

#### Blends in the cup

**Simple, Clean Process** – Just add ingredients to cup, insert cup in machine, and press start. It blends and stops automatically and the drink is ready to serve.

**Saves Ingredients and Time** – No more wasted ingredients in blender jar and it eliminates the step of emptying, cleaning, and storing jars.

**Saves Water** – Rinses with as little as 10 oz./300ml of water. It reduces water usage by 8 times compared to manual cleaning.

**Increases Productivity** – Staff can perform other tasks while the machine blends.

## MIC2000 Series

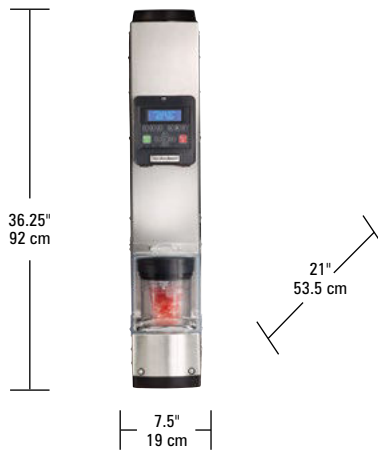

### SmartServe™

#### Self-serve or crew-serve convenience

**Mixes Milk Shakes or Incorporates Mix-Ins** – Makes it easy for customers or crew members to mix treats.

**Simple, Clean Process** – Just add ingredients to cup, insert cup in machine, and press start. It mixes and stops automatically and the treat is ready to serve.

**Can Add Water Automatically While Blending** – Helps ingredients blend efficiently.

**Saves Water** – Rinses with as little as 10oz./300ml of water. It reduces water usage by 8 times compared to manual cleaning.

**Increases Productivity** – Staff can perform other tasks while the machine blends.

## BIC3000 Series

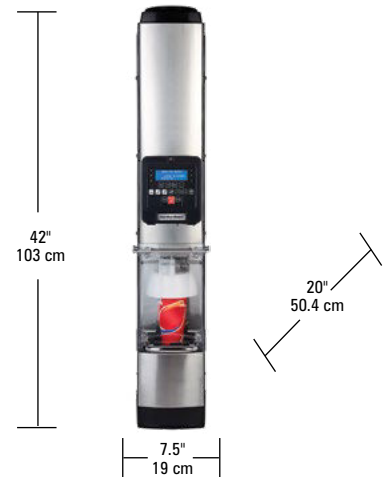

### SmartServe™

#### Blends in the cup

**Mixes Milk Shakes or Incorporates Mix-Ins** – Makes it easy for customers or crew members to mix treats.

**Simple, Clean Process** – Just add ingredients to cup, insert cup in machine, and press start. It blends and stops automatically and the drink is ready to serve.

**Rotating Cup Holder** – Automatically rotates cup as it mixes for evenly mixed treats.

**Saves Water** – Rinses with as little as 10 oz./300ml of water. It reduces water usage by 8 times compared to manual cleaning.

**Increases Productivity** – Staff can perform other tasks while the machine blends.



**Ship Weight:** 103 lbs/47 kg  
**Warranty:** 1 year parts & labor

#### 230 V Specifications:

BIC2000-CE  
BIC2000-UK  
220-240 V~, 60 HZ, 2 A

RoHS COMPLIANT



**Ship Weight:** 103 lbs/47 kg  
**Warranty:** 1 year parts & labor

#### 230 V Specifications:

MIC2000-CE  
MIC2000-UK  
220-240 V~, 50-60 HZ, 2 A

RoHS COMPLIANT



**Ship Weight:** 105 lbs/48 kg  
**Warranty:** 1 year parts & labor

#### 120 V Specifications:

BIC3000  
120 V~, 60 HZ, 6.2 A





# Drink Mixers

Mixing perfect shakes since 1911

## HMD200 Series



### Single Spindle

Mixes one shake

**Versatile Drink and Food Prep** – Great for everything from mixing shakes and “flashing” bar drinks to blending eggs and batters.

**Excellent Mixing Performance** – Powerful 1/3 HP precision motor is balanced to minimize vibration and is built to last with sealed, permanently lubricated ball bearings. Operator can easily replace motor in minutes.

**Two-Way Motor Activation** – Operators can start and stop mixing action by inserting the cup into the cup guide, or by using the pulse switch on the top of the mixer.

**Easy to Clean** – Smooth housing made of stainless steel and die-cast aluminum. Cup guide removes for cleaning.

**Sealed Housing** – Eliminates the risk of water ingress and motor failure.

## HMD300 Series



### Wall Mount

Saves space

**Saves Valuable Counter Space** – Fully featured in convenient wall-mount design, and plugs into standard outlet.

**Excellent Mixing Performance** – Powerful 1/3 HP precision motor is balanced to minimize vibration and is built to last with sealed, permanently lubricated ball bearings. Operator can easily replace motor in minutes.

**Two-Way Motor Activation** – Operators can start and stop mixing action by inserting the cup into the cup guide, or by using the pulse switch on the top of the mixer (120 V only).

**Easy to Clean** – Smooth housing made of stainless steel and die-cast aluminum.

**Sealed Housing** – Eliminates the risk of water ingress and motor failure.

## HMD400 Series



### Triple Spindle

High-volume applications

**Ideal for High Volume** – All the features of the single spindle mixer with triple the volume.

**Excellent Performance** – Powerful 1/3 HP motor for each spindle, each with its own controls.

**Precision Motor** – Balanced to minimize vibration and built to last with sealed, permanently lubricated ball bearings.

**Two-Way Motor Activation** – Operators can start and stop mixing action by inserting the cup into the cup guide, or by using the pulse switch on the top of the mixer.

**Easy to Clean** – Smooth housing made of stainless steel and die-cast aluminum. Cup guide removes for cleaning.

**Sealed Housing** – Eliminates the risk of water ingress and motor failure.



**Ship Weight:** 15.4 lbs / 7.0 kg

**Warranty:** 1 year parts & labor

#### 120 V Specifications:

HMD200  
120 V~, 60 HZ, 300 W



#### 230 V Specifications:

HMD200P-CE  
HMD200P-UK  
HMD200P-CCC  
220-240 V~, 50-60 HZ, 300 W



**Ship Weight:** 10.5 lbs / 4.8 kg

**Warranty:** 1 year parts & labor

#### 120 V Specifications:

HMD300  
120 V~, 60 HZ, 250 W



#### 230 V Specifications:

HMD300-CE  
HMD300-UK  
220-240 V~, 50-60 HZ, 250 W



**Ship Weight:** 37.6 lbs / 17.1 kg

**Warranty:** 1 year parts & labor

#### 120 V Specifications:

HMD400  
120 V~, 60 HZ, 900 W



#### 230 V Specifications:

HMD400P-CE  
HMD400P-UK  
HMD400P-CCC  
220-240 V~, 50-60 HZ, 900 W



**We invented the first drink mixer over 100 years ago,** and we're still going strong today with our wide selection of world-class mixing machines. From timeless drink mixers to heavy-duty mixing machines, you'll get all the mixing control and power you need, whether you're preparing creamy milk shakes with hard ice cream or soft-serve creations with candy mix-ins.

## HMD880 Series



### MixStation™ Heavy-duty mixing

**Brushless Induction Motor** – Provides quiet operation and worry-free use.

**Single speed operation** – Operators can easily start and stop mixing action by flipping the switch.

**Wide Working Space** – Allows easy maneuvering of cup without restrictions.

**Contoured Splash Shield** – Reduces discomfort on the operator's wrist.

**Easy To Clean** – Smooth, rounded corners easily wipe clean. Drip tray and magnetic splash shield are removable.

**Optional Foot Pedal** – For hands-free power activation (120 V only).

## HMD1000 Series



### MixStation™ Heavy-duty mixing with more control

**Powerful Mixing Performance** – 3/4 HP motor provides heavy-duty mixing action for ice cream treats with candy, fruit, and nut mix-ins.

**Pre-programmed Cycles** – Deliver consistent results regardless of the operator with option to upload custom programs via USB

**Variable Speed Dial** – Provides maximum flexibility and customization.

**Capacitive Touch Controls** – Sealed for easy cleaning.

**Contoured Splash Shield** – Reduces discomfort on the operator's wrist.

**Easy To Clean** – Smooth, rounded corners easily wipe clean. Drip tray and magnetic splash shield are removable.

**Optional Foot Pedal** – or hands-free power activation (120 V only).

## ACCESSORIZE

### HMD300M Series Machine-Mount Drink Mixer

Specially designed to attach to soft-serve ice cream machines to add drink-making flexibility to your operation



### 110E Stainless Steel Cup

Holds 32 oz. (.95L) and is compatible with all drink mixers



### 928 Agitator

Compatible with all HBC drink mixers



### 929 Agitator

Compatible with all HBC drink mixers



**120 V Ship Weight:** 32 lbs / 14.5 kg  
**Warranty:** 1 year parts & labor

#### 120 V Specifications:

HMD880  
120 V~, 60 HZ, 4.8 A



#### 230 V Specifications:

HMD880-CE  
HMD880-UK  
HMD880-CN  
220-240 V~, 50-60 HZ, 5.4 A



RoHS COMPLIANT



**120 V Ship Weight:** 27 lbs / 12.2 kg  
**Warranty:** 1 year parts & labor

#### 120 V Specifications:

HMD1000  
120 V~, 60 HZ, 6.0 A



#### 230 V Specifications:

HMD1000-CE  
HMD1000-UK  
HMD1000-CN  
220-240 V~, 50-60 HZ, 6.5 A



RoHS COMPLIANT



Turn to page 24 for our complete selection of Drink Mixer accessories

# Coffee Urns

Serving coffee for a crowd

## HCU040S



### 40 Cup Coffee Urn

Brews 1 Cup Per Minute

**One Hand Dispensing** – Fills cups fast for superior service.

**Double-Wall, Insulated Tank** – Reduces risks of hand burns by keeping outside cooler.

**Dual Heaters and Indicator Lights** – Brew and gentle warm.

**Convenient Locking Lid** – A quick twist locks lid in place.

**Removable Stainless Steel Brew Basket**

**Embossed Level Marks Inside Urn** – For exact measurement of coffee.

**Boil Dry Protection** – Shuts off when empty

**Easy Lift Handles**



**Ship Weight:** 11.5 lbs / 5.2 kg

**Warranty:** 1 year parts & labor

**120 V Specifications:**

HCU040S

120 V~, 60 HZ, 1440 W



## HCU075S



### 75 Cup Coffee Urn

Brews 1 Cup Per Minute

**One Hand Dispensing** – Fills cups fast for superior service.

**Double-Wall, Insulated Tank** – Reduces risks of hand burns by keeping outside cooler.

**Dual Heaters and Indicator Lights** – Brew and gentle warm.

**Convenient Locking Lid** – A quick twist locks lid in place.

**Removable Stainless Steel Brew Basket**

**Embossed Level Marks Inside Urn** – For exact measurement of coffee.

**Boil Dry Protection** – Shuts off when empty

**Easy Lift Handles**



**Ship Weight:** 14 lbs / 6.4 kg

**Warranty:** 1 year parts & labor

**120 V Specifications:**

HCU075S

120 V~, 60 HZ, 1440 W



## HCU100S



### 100 Cup Coffee Urn

Brews 2 Cups Per Minute

**One Hand Dispensing** – Fills cups fast for superior service.

**Double-Wall, Insulated Tank** – Reduces risks of hand burns by keeping outside cooler.

**Dual Heaters and Indicator Lights** – Brew and gentle warm.

**Convenient Locking Lid** – A quick twist locks lid in place.

**Removable Stainless Steel Brew Basket**

**Embossed Level Marks Inside Urn** – For exact measurement of coffee.

**Boil Dry Protection** – Shuts off when empty

**Easy Lift Handles**



**Ship Weight:** 15 lbs / 6.8 kg

**Warranty:** 1 year parts & labor

**120 V Specifications:**

HCU100S

120 V~, 60 HZ, 1440 W



**Meet all your hospitality needs.** From large groups at hotels and conventions to catering applications, churches or other gatherings, our comprehensive selection of commercial coffee urns meets every need. Every coffee urn is exceptionally easy to use and clean, and the stainless steel models offer removable tanks for even easier filling and cleaning. No matter what size crowd or budget you have, you'll find one that's just right for you.

## D50065



### Coffee Urn 60 Cup Capacity

**One-Hand Dispensing** – Fills cups fast with one hand to shorten the wait.

**Classic Polished Stainless Steel Exterior** – For long-lasting performance.

**Keep Warm Heater** – Maintains coffee's optimal temperature for fresh flavor with less bitterness.

**Water/Coffee Window** – Makes filling easy and shows you at a glance when coffee level is low.

**Ready Light** – Shows you when brew cycle is complete.

**Stainless Steel Interior** – Resists stains and buildup for easy cleaning.

**Glass Knob On Lid** – Lets you view the brewing cycle.



**120 V Ship Weight:** 11.5 lbs / 5.21 kg

**Warranty:** 1 year parts & labor

#### Specifications:

D50065

120 V~, 60 HZ, 1000 W



# Expeditor™ Family of Culinary Blenders

## Creating the perfect blend for chefs

### HBF510 Series



**HBF510 (120 V)**

**HBF510 (230 V)**

**64 oz./1.4 L BPA Free Co-Polyester Container**

**Variable Speed & Pulse Functions** –

Allow for easier blending, pureeing, grinding, chopping, and emulsifying.

**Chop Function** – Cycles between low speed and operator-selected high speed.

**2.4 Peak HP\* Motor** – Has the torque needed for blending ingredients.

**Sealed Paddle Switches** – Leak resistant and easy to use.

**Durable Metal Drive Coupling**

**Large Dosing Cup** – Makes it easier to add liquid for emulsions while blending.

**Stainless Steel Blades** – Quickly cut through every ingredient.

**Lid Open Sensor** – prevents blending when lid is removed (230 V only).



**HBF510S (120 V)**

**HBF510S (230 V)**

**64 oz./1.8 L Container**

**Variable Speed & Pulse Functions** – Blending, pureeing, grinding, chopping, and emulsifying.

**Chop Function** – Cycles between low speed and operator-selected high speed.

**2.4 Peak HP\* Motor** – Has the torque needed for chopping ingredients.

**Stainless Steel Container** – Provides durability and has an easy-grip handle.

**Durable Metal Drive Coupling**

**Large Dosing Cup** – Makes it easier to add liquid for emulsions while blending.

**Stainless Steel Blades** – Quickly cut through every ingredient.

**Sealed Paddle Switches** – Leak resistant and easy to use.

**Lid Open Sensor** – prevents blending when lid is removed (230 V only).

### HBF600 Series



**HBF600**

**64 oz./1.8 L Container**

**Variable Speed & Pulse Functions** –

Allow for easier blending, pureeing, grinding, chopping, and emulsifying.

**One-Touch Chop Function** – Cycles between low speed and operator-selected high speed.

**3 HP Motor** – Provides the torque needed for effectively blending ingredients.

**Patented Wave~Action® Container** – Keeps contents circulating through blades to ensure that contents are consistently incorporated.

**Large Dosing Cup** – Makes it easier to add liquid for emulsions while blending.

**Temperature Gauge** – Alerts operator if motor overheats while blending back-to-back batches.



**Ship Weight:** 12.3 lbs / 5.6 kg

**Warranty:** 2 years parts & labor

**120 V Specifications:**

HBF510  
120 V~, 60 HZ, 10 A



**230 V Specifications:**

HBF510-CE  
HBF510-UK  
220-240 V~, 50-60 HZ, 6.5 A



**Ship Weight:** 13.9 lbs / 6.3 kg

**Warranty:** 2 years parts & labor

**120 V Specifications:**

HBF510S  
120 V~, 60 HZ, 6.5 A



**230 V Specifications:**

HBF510S-CE-UK  
HBF510S-CN  
220-240 V~, 50-60 HZ, 6.5 A



**Ship Weight:** 14 lbs / 6.4 kg

**Warranty:** 3 years parts & labor (lifetime on motor drive coupling and blade)

**120 V Specifications:**

HBF600  
120 V~, 60 HZ, 13 A



**230 V Specifications:**

HBF600-CE  
HBF600-UK  
220-240 V~, 50-60 HZ, 750 W





**Ordinary blenders can't compete with Expeditor™ blenders** when it comes to culinary output and precision. From blending soups and sauces to emulsifying marinades and dressings, these culinary blenders help talented chefs around the world express their artistic vision. Even better, their intelligent controls and large capacities maximize speed-to-table so you can uphold impeccable service.

### HBF900S Series

### HBF1100S Series



**HBF600S-CE/-UK**



**HBF900S**



**HBF1100S**

**64 oz./1.8 L Container**

**Variable Speed & Pulse Functions –**

Allow for easier blending, pureeing, grinding, chopping, and emulsifying.

**One-Touch Chop Function –** Cycles between low speed and operator-selected high speed.

**3 HP Motor –** Provides the torque needed for effectively chopping ingredients.

**Stainless Steel Container –** Provides durability and features a comfortable, easy-to-grip handle.

**Large Dosing Cup –** Makes it easier to add liquid for emulsions while blending.

**Temperature Gauge –** Alerts operator if motor overheats while blending back-to-back batches.

**1 gallon/4 L Container**

**Heavy-Duty Construction –** Built for long-lasting performance in the world's busiest kitchens.

**Saves Prep Time –** With its powerful 3.5 HP motor and 1 gallon (4 L) container, this blender is fully equipped to produce great results in a fraction of the time.

**Low-Profile Design –** Offers convenient access to container on any kitchen countertop. Also makes it easy to move the blender from one kitchen location to another.

**Easy-to-Use Controls –** 3 speeds plus pulse provide precision every time.

**Lid Interlock –** Ensures the blender won't start until the jar and lid are securely in place.

**Transparent Lid and Dosing Cup –** Gives operators a clear view while blending.

**1 gallon/4 L Container**

**Saves Prep Time –** Powerful 3.5 HP motor and large container help you finish blending jobs faster.

**Low-Profile Design –** For convenient access to the container on any countertop.

**Unique Chop Function –** Provides improved blending performance.

**Custom Program Buttons –** Offer a large degree of custom blending and precision control.

**Variable Speed Dial –** Allows blending from a very low speed to a high speed that quickly creates a smooth puree.

**Preset Timer Buttons –** Gives operators more time to perform other kitchen tasks.

**Lid Interlock –** Ensures that the blender won't start until the jar and lid are securely in place.



**Ship Weight:** 14.21 lbs / 6.5 kg

**Warranty:** 3 years parts & labor (lifetime on motor drive coupling and blade)

**120 V Specifications:**

HBF600S  
120 V~, 60 HZ, 13 A



**230 V Specifications:**

HBF600S-CE  
HBF600S-UK  
HBF600S-CCC  
220-240 V~, 50-60 HZ, 750 W



**Ship Weight:** 24.3 lbs/11 kg

**Warranty:** 3 years parts & labor (lifetime on motor drive coupling and blade)

**120 V Specifications:**

HBF900S  
120 V~, 60 HZ, 14 A



**230 V Specifications:**

HBF1100S-CE  
HBF1100S-UK  
HBF1100S-CN  
220-240 V~, 50-60 HZ, 1500 W



# Back-of-the-House Equipment

Providing versatility and durability

## CPM800 Series

## 37590

## HCO500



### Stand Mixer

#### Powerful performance

**8 Quart (8 L) Capacity** – Small enough for the countertop, yet robust enough to handle any mixing job.

**Tilt-Back Head** – Makes it easy to add ingredients, scrape sides, change attachments, and remove the bowl.

**Stainless Steel Bowl with Handles** – Makes it easy to lift and carry contents.

**Heavy-Duty Attachments** – Stainless steel beater, dough hook & wire whisk with splash shields to keep ingredients away from the hub area.

**Variable 7 Speed Dial + Pulse** – Allows for speed changes while mixing.

**Sealed Stop/Start Buttons** – Easily respond to touch for ease of use.



### Rice Cooker

#### 90 cup

**Extra-Large Capacity** – Lets you cook 90 cups of cooked rice (45 cups uncooked).

**Digital Control Panel** – Provides multiple cooking options and is easy to keep clean.

**Heat/Simmer Function** – Maintains the right temperature to help prevent boilover for up to 4 hours.

**Insulated Double-Wall Construction** – With hinged/heated lid that's easy to open and close.

**Nonstick Inner Pot with Handles** – Makes it easy to lift and carry contents.

**Condensation Cup** – Collects water to keep messy drips off countertops.

**Accessories Included** – Rice measuring cup and paddle.

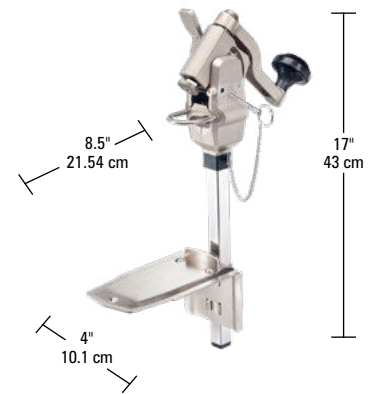

### Side-Cut Can Opener

#### No more sharp edges

**Opens Seam of Can** – Cans are opened on the side seam instead of puncturing the lid, so there's no sharp edges.

**No Cross Contamination** – No blade to make contact with food, unlike conventional can openers.

**No Risk of Metal Shavings** – Since the lid is not being cut with a blade, metal shavings won't get into the food.

**No Gears to Wear or Break** – Removes the possibility of downtime.

**Durable Construction** – Made of stainless steel and nickel-plated aluminum for durable performance.

**Same Mounting Pattern as Edlund\*** – for easy installation.



**Ship Weight:** 35 lbs / 25 kg

**Warranty:** 2 years parts & labor

**120 V Specifications:**

CPM800  
120 V~, 60 HZ, 800 W/ 7A



**230 V Specifications:**

CPM800-CE  
CPM800-UK  
CPM800-CN  
220-240 V~, 50-60 HZ, 1500 W, IPX2



**Ship Weight:** 37.7 lbs / 16.2 kg

**Warranty:** 1 year parts & labor

**240 V Specifications:**

37590  
240 V~, 60 HZ, 2500 W  
NEMA 6-15P type plug



Conforms to NSF/ANSI Std. 8



**220 V Specifications:**

37590-CN  
220 V~, 50 HZ, 2500 W



**Ship Weight:** 4.5 lbs / 2 kg

**Warranty:** 2 years parts & labor



\* Edlund is the trademark of Edlund Company, Inc. Use of the mark does not suggest any affiliation or endorsement by Edlund Company.

**By saving valuable time and labor,** these versatile kitchen tools can help every commercial food operation improve their bottom line. From small shops to large restaurants, our hard-working tools are the ones to keep on hand when you need to mix cookie doughs or cake batters, prepare perfect rice, open cans, or serve food with consistent portion sizes.

78



## 78 Series Dishers

### Classic style

**Portion Control** – Each of the 9 disher sizes lets you serve consistent portions every time. Choose from the smallest purple disher with 1-1/2" bowl diameter to the largest white disher with 3" bowl diameter.

**Color-Coded Handles** – Bright, identifiable colors make it easy to select the correct disher for improved service and correct portion sizes.

**Durable Stainless Steel** – The bowl, thumb lever, and spring are made of stainless steel for long life and easy cleanup in the dishwasher.

**Heavy-Duty Spring Action** – The heavy-duty stainless steel spring allows for ease of operation and long-lasting durability.

80



## 80 Series Dishers

### Deluxe style

**80 series dishers have all the features of the 78 series shown left, plus these extras:**

**Pan Rest™ Feature** – These convenient notches in the handles let the dishers rest on the edge of pans to help prevent slippage that could slow down service.

**Ergonomic Grip** – Handles are shaped to create a comfortable grip, which helps reduce hand and arm fatigue.

**Imprinted Capacity** – Since the capacity of each disher is clearly molded onto the handle, there's never a question about which size disher is being used.



**Ship Weight:** Varies depending on size

**Warranty:** 1 year parts & labor (78 series) 2 year parts & labor (80 series)

Color	Disher size	Bowl diameter	Milliliters*	Fluid oz.*	Fluid oz. fractional**	Wt./oz.*
○ White	6	3"	138	4.66	4¾"	4.86
○ Grey	8	2¾"	108	3.64	3¾"	3.80
○ Ivory	10	2⅝"	94	3.19	3¼"	3.33
● Green	12	2½"	82	2.78	2¾"	2.90
● Blue	16	2¼"	61	2.07	2"	2.16
● Yellow	20	2⅛"	52	1.77	1¾"	1.84
● Red	24	2"	44	1.49	1½"	1.56
● Black	30	1¾"	30	1.03	1"	1.07
● Orchid	40	1½"	20	0.68	¾"	0.70

\* Water capacity \*\* Approximate

# Immersion Equipment

The dependable workhorses of your foodservice kitchen

## HMI Series of Immersion Blenders

# BigRig™

## BigRig™ Immersion Blender

### Most Powerful Motor in its Class\*

**Stainless Steel Shaft with Ergonomic Grip** – Detaches to let you change to a different-size shaft.

**ThumbDrive™ Variable Speed Dial** – With color-coded light for immediate feedback about blender status.

### Continuous Run Operation for High-Volume Blending

**Stainless Steel Blade with Guard** – Blends, chops, purees, or emulsifies ingredients quickly.

**Ergonomic Design with Light-Touch Controls** – Offers multiple hand positions.

**Wall Mount and Cord Holder** – For neat, easy storage.

**Serviceable 12 ft./365cm Power Cord Designed for High Visibility**

\* 800 watts for 120 V; 1000 watts for 220-240 V



**Interchangeable Shaft Sizes Available (sold separately)**



- 12"/305mm
- 14"/355mm
- 16"/406mm
- 18"/457mm
- 21"/533mm



**Warranty:** 2 years parts and labor

### Shipping Weights:

HMI012	HMI014	HMI016	HMI018	HMI021	HMI02W
13.5 lbs	13.7 lbs	13.9 lbs	14.1 lbs	15.2 lbs	6.0 lbs
6.1 kg	6.2 kg	6.3 kg	6.4 kg	7.0 kg	2.7 kg

### HMI (120 V) Specifications:

120 V~, 60 HZ, 800 W



### HMI (230 V) Specifications:

-CE  
-UK  
-CN  
220-240 V~, 50-60 HZ, 1000 W, IPX1



**Built for chefs and foodservice professionals,** the BigRig™ family of immersion blenders create large batches without sacrificing time or quality. Since they have the most powerful motors in their class,\* they quickly power through every high-volume blending, chopping, and emulsifying job. ThumbDrive® color-coded speed dials and ergonomic handles guarantee operators' comfort and convenience.

## HMI200

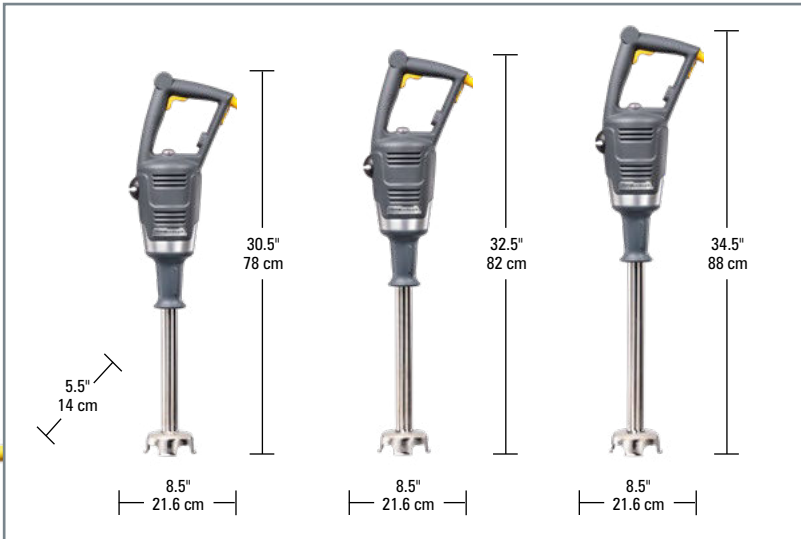

HMI012

HMI014

HMI016



HMI018

HMI021

HMI02W

### Blend Volume Chart

- 12"/305mm shaft - up to 6 gal. (23 L)
- 14"/355mm shaft - up to 14 gal. (53 L)
- 16"/406mm shaft - up to 23 gal. (87 L)
- 18"/457mm shaft - up to 32 gal. (121 L)
- 21"/533mm shaft - up to 42 gal. (158 L)



### Immersion Blender 9" shaft

**Stainless Steel 9"/23cm Shaft** – Not only does the thick 9"/23 cm shaft reach into deep pots and bowls, it detaches for easy cleaning.

**Flexibility** – Detachable blending attachment plus two speeds give professional kitchens the flexibility they need to purée soups and sauces right in the pan, whip egg whites, cream butters and mix batters with ease.

**Heavy Duty** – Long-life motor construction and stainless steel blending attachment designed for foodservice applications.

**Innovative Blade Guard** – Keeps prep areas neat and saves time by reducing messy splashing and clogging.

**Double-Insulated** – With two-conductor cord for easier use and storage.



**Ship Weight:** 4.2 lbs / 1.9 kg

**Warranty:** 1 year parts & labor

#### 120 V Specifications:

HMI200  
120 V~, 60 HZ, 175 W



#### 230 V Specifications:

HMI200-CE  
HMI200-UK  
HMI200-CCC  
220-240 V~, 50-60 HZ, 175 W



RoHS COMPLIANT



# FreshMark™ Family of Juicers

Maximizing juice output

932

HCJ967 Series



## Manual Citrus

**Fills a glass of juice in less than a minute**

**20-50 Glasses Daily** – Ideal for operations that serve up to 50 glasses of juice per day.

**Citrus Versatility** – Designed to extract juice from lemons, limes, oranges, and grapefruits.

**Maximum Juice Extraction** – Exerts up to 2000 lbs. of force to ensure maximum juice output.

**Acid-Resistant Finish** – Resists wear and tear from exposure to citrus acids.

**Stainless Steel Strainer Cone** – Removes for easy cleaning in the dishwasher.

**5.5" Cup Clearance** – Provides ample room to place an 8-10 oz. cup underneath for juicing.

**Sure Grip™ Feet** – Keep the juicer firmly in place.

## Electric Citrus

**Fills a glass of juice in less than 30 seconds**

**100+ Glasses Daily** – For operations that serve up to 100 glasses of juice per day.

**Citrus Versatility** – Designed to extract juice from lemons, limes, oranges, and grapefruits.

**Exceptionally Quiet** – The brushless induction motor is barely audible, so operators can more easily focus on customers.

**Heavy-Duty Construction** – Designed to withstand continuous juicing. Die-cast aluminum base makes the juicer less prone to tipping over.

**3 Metal-Reinforced Reamers** – Maximize juice output from small to large citrus fruits.

**Stainless Steel Juice Bowl** – Removes for easy cleaning.

**Extra-Tall (8.5"/21.6cm) Spout** – Accommodates everything from small juice glasses to large pitchers.



**Ship Weight:** 13.2 lbs / 6 kg  
**Warranty:** 1 year parts & labor



**Ship Weight:** 30 lbs / 13.6 kg  
**Warranty:** 2 years parts & labor

### 120 V Specifications:

HCJ967  
120 V~, 60 HZ, 3 A



### 230 V Specifications:

HCJ967-CE  
HCJ967-UK  
HCJ967-CN  
220-240 V~, 50-60 HZ, 250 W



**We've built commercial-quality juicers since 1932**, when our 932 manual juicer first made its mark. Today the FreshMark™ family of commercial juicers offers businesses the maximum output they need in order to keep the juice flowing. Whether you run a juice shop, bar, supermarket, or a chain of restaurants, each one is expertly designed to offer you excellent juicing performance you can count on every single day.

## HWG800



### Wheatgrass

Extracts up to 5 oz./150ml per minute

**Versatile Extraction** – Designed to extract juice from wheatgrass, ginger, and leafy herbs.

**Powerful, High-Torque Motor** – Provides optimal juice extraction for maximum yield.

**Durable Construction** – Solidly built for rigorous professional use with stainless steel components and permanently lubricated, air-cooled motor.

**Surgical-Grade Internal Assembly** – Top-quality 304 surgical grade stainless steel parts provide long life.

**Removable Food Zone Parts** – Can be quickly removed for fast, easy cleaning.

**Convenient Toggle Switch** – Includes a reverse option for cleaning after extracting dry herbs and sprouts.

**Maintenance Kit Included** – Comes with 2 metal screens and two gaskets.

## HJE960 Series



### otto™ The Juice Extractor

Extracts approximately 2 qts. / 2L per minute

**100+ Glasses Daily** – For operations that require large yields of juice from a variety of produce and/or serve 100 or more glasses of juice per day.

**Centrifugal Extraction** – Extracts juice from apples, carrots, cucumbers, celery, red beets, ginger, leafy greens, and more.

**Powerful Brushless Induction Motor** – Provides quiet operation and has dual cooling fans for continuous juicing.

**Heavy-Duty Die-Cast Base** – Provides exceptional durability and keeps juicer sitting securely on the countertop.

**3" (76cm) Feed Chute Opening** – Minimizes prep time.

**Simple Single-Speed Operation** – For effortless juicing.

**Top-Quality Parts** – Stainless steel and BPA-free parts provide exceptional durability and are easy to clean.

**Heavy-Duty Metal Handle** – withstands repeated opening and closing and stops motor before lid can be opened.



**Ship Weight:** 37 lbs / 17 kg  
**Warranty:** 1 year parts & labor

#### 120 V Specifications:

HWG800  
120 V~, 60 HZ, 375 W



E302938 Conforms to  
ANSI/NF58 NSF/ANSI Std 8



**Ship Weight:** 75.6 lbs / 34.3 kg  
**Warranty:** 2 years parts & labor

#### 120 V Specifications:

HJE960  
120 V~, 60 HZ, 8.5A



#### 230 V Specifications:

HJE960-CE  
HJE960-UK  
HJE960-CN (50 mm feed chute)  
220-240 V~, 50-60 HZ, 1200 W



RoHS COMPLIANT



Passes IPX1 water rating

# PrimaVac™ Family of Vacuum Packaging

Preserving food's freshness and flavor

## HVC254 Series



## HVC305 Series



## HVC406 Series



### PrimaVac™ In-Chamber

#### 10" (254mm) seal bar

**10 Custom Programs** – Let you adjust vacuuming and sealing times for different needs and recipes.

**Powerful JetAire™ 8 m3/h Vacuum Pump** – Provides robust, long-lasting service.

**Adjustable Soft Air** – Protects delicate food.

**Adjustable Sealing and Cooling Time** – Lets you customize sealing action to your exact preference and applications.

**Oil Change Reminder** – Helps ensure that you maintain a top-functioning pump.

**Durable Stainless Steel Housing** – Ensures long-lasting beauty and is easy to clean.

**Accessories and Power Cords Included** – Comes with 80 pouches, filler plate, tools, and electrical cords for UK, Continental Europe, and China.

#### 12" (305mm) seal bar

**10 Custom Programs** – Let you adjust vacuuming and sealing times for different needs and recipes.

**Powerful JetAire™ 12 m3/h (120 V), 10 m3/h (230 V) Vacuum Pump** – Provides robust, long-lasting service.

**Adjustable Soft Air** – Protects delicate food.

**Adjustable Sealing and Cooling Time** – Lets you customize sealing action to your exact preference and applications.

**Oil Change Reminder** – Helps ensure that you maintain a top-functioning pump.

**Durable Stainless Steel Housing** – Ensures long-lasting beauty and is easy to clean.

**Accessories and Power Cords Included** – Comes with 80 pouches, filler plate, tools, and electrical cords for UK, Continental Europe, and China.

#### 16" (406mm) seal bar

**Gas Flush** – Creates a protective cushion to keep food from being crushed.

**10 Custom Programs** – Let you adjust vacuuming and sealing times for different needs and recipes.

**Powerful JetAire™ 24 m3/h (120 V), 20 m3/h (230 V) Vacuum Pump** – Provides robust, long-lasting service.

**Adjustable Soft Air** – Protects delicate food.

**Adjustable Sealing and Cooling Time** – Lets you customize sealing action to your exact preference and applications.

**Oil Change Reminder** – Helps ensure that you maintain a top-functioning pump.

**Accessories and Power Cords Included** – Comes with 80 pouches, filler plate, tools, and electrical cords for UK, Continental Europe, and China.



**Ship Weight:** 80 lbs/36.3 kg

**Warranty:** 2 years parts & labor; 3 years with product registration

**HVC254  
120 V Specifications:**  
120 V~, 60 HZ, 300 W, 3A



**HVC254-CE  
220 V Specifications:**  
220-240 V~, 50-60 HZ, 350 W



RoHS COMPLIANT



**Ship Weight:** 94 lbs/42.6 kg

**Warranty:** 2 years parts & labor; 3 years with product registration

**HVC305  
120 V Specifications:**  
120 V~, 60 HZ, 5 A



**HVC305-CE  
220 V Specifications:**  
220-240 V~, 50-60 HZ, 350 W



RoHS COMPLIANT



**Ship Weight:** 190 lbs/86 kg

**Warranty:** 2 years parts & labor; 3 years with product registration

**HVC406  
120 V Specifications:**  
120 V~, 60 HZ, 10 A



**HVC406-CE  
220 V Specifications:**  
220-240 V~, 50-60 HZ, 850 W



RoHS COMPLIANT



**With PrimaVac™ vacuum packaging machines,** commercial kitchens can accomplish a wide variety of tasks, from preserving food's freshness to giving chefs the ability to prep dishes for sous vide. Along with our selection of PrimaVac™ machines, we also offer an external vacuum sealer for smaller applications and a sous vide immersion circulator.

## HSV1000 Series



### AcuVide™ 1000 Sous Vide Circulator

**1200 Watt Water Heater** – Keeps up to 8 gallons (30 L) of water at an even, consistent temperature for uniform cooking.

**IPX7 Construction** – Prevents malfunction if accidentally dropped in water.

**Adjustable Timer with Easy-to-Read Display** – Select up to 99 hours of sous vide time and set water temperature in your choice of Fahrenheit or Celsius.

**Stainless Steel Lower Housing** – Removes for easy cleaning.

**Cleaning Cycle and Reminder** – Helps keep the circulator in top performance.

**Water Level Marks and Warning Signal** – Help unit run uninterrupted.

**Adjustable Clamp** – Allows for best placement in vessel and secures without tools.

## HVS400R



### PrimaVac™ External 16" (406mm) seal bar

**One-Touch Operation** – Automatically sequences machine from vacuuming to sealing to releasing.

**16" (40.6cm) Seal Bar** – For sealing wide bags or two smaller bags at once.

**LED lights** – Indicate each vacuuming stage.

**Powerful Double-Piston Pump** – For fast vacuuming.

**Durable Stainless Steel Housing** – Ensures long-lasting beauty and is easy to clean.

**Optional Manual Mode** – Perfect for using rolls or for sealing soft foods.

**Transparent Lid** – For easy bag alignment.

## ACCESSORIZE

Equip your kitchen with the vacuum sealer pouches and bags your staff needs for food storage and sous vide applications.

### In-Chamber Sealer Pouches

- FDA-approved for temperatures above 121 °C (249 °F)
- Made of 9 layers of smooth PA and PE for oxygen barrier and puncture protection
- Available in 3 and 4 mil thicknesses



### External Vacuum Sealer Bags

- Heavy-duty embossed bags for efficient air removal and airtight seal
- BPA-free and FDA-approved for storage
- Available in 3 sizes in 3 mil thickness



See next page for complete selection of bags and pouches



**Ship Weight:** 4 lbs/2 kg

**Warranty:** 1 year parts & labor

#### 120 V Specifications:

HSV1000  
120 V~, 60 HZ, 1200 W



#### 230 V Specifications:

HSV1000-CE  
HSV1000-UK  
HSV1000-CN  
220-240 V~, 50-60 HZ, 1200 W



RoHS COMPLIANT



**Ship Weight:** 26 lbs/11.8 kg

**Warranty:** 1 year parts & labor

#### 120 V Specifications:

HVS400R  
120 V~, 60 HZ, 1020 W



## Vacuum Packaging Pouches and Bags

<b>PrimaVac</b>	<b>Width IN/MM</b>	<b>Length IN/MM</b>	<b>Mil/ Microns</b>	<b>Count per Case</b>
<b>In-Chamber 3 MIL</b>	3 mil is the standard thickness for storing, freezing, or boiling food in individual servings or large quantities.			
HVCP30608	6 / 152	8 / 203	3 MIL / 75 $\mu$ m	1000
HVCP30610	6 / 152	10 / 254	3 MIL / 75 $\mu$ m	1000
HVCP30810	8 / 203	10 / 254	3 MIL / 75 $\mu$ m	1000
HVCP30812	8 / 203	12 / 305	3 MIL / 75 $\mu$ m	1000
HVCP31013	10 / 254	13 / 330	3 MIL / 75 $\mu$ m	1000
HVCP31015	10 / 254	15 / 381	3 MIL / 75 $\mu$ m	1000
HVCP31214	12 / 305	14 / 335	3 MIL / 75 $\mu$ m	1000
HVCP31216	12 / 305	16 / 406	3 MIL / 75 $\mu$ m	500
<b>In-Chamber 4 MIL</b>	4 mil provides extra protection against tears from bones or sharp contents.			
HVCP40610	6 / 152	10 / 254	4 MIL / 100 $\mu$ m	1000
HVCP40810	8 / 203	10 / 254	4 MIL / 100 $\mu$ m	1000
HVCP40812	8 / 203	12 / 305	4 MIL / 100 $\mu$ m	1000
HVCP41013	10 / 254	13 / 330	4 MIL / 100 $\mu$ m	1000
HVCP41214	12 / 305	14 / 335	4 MIL / 100 $\mu$ m	1000
<b>In-Chamber Retherm</b>	Retherm pouches are available in 3 or 4 mil. and feature reinforced corners that help the bags withstand exposure to heat.			
HVCPR30812	8 / 203	12 / 305	3 MIL / 75 $\mu$ m	1000
HVCPR31015	10 / 254	15 / 381	3 MIL / 75 $\mu$ m	1000
HVCPR41216	12 / 305	16 / 406	4 MIL / 100 $\mu$ m	500
<b>External Vacuum Bags</b>	Bags are for use with external vacuum sealers and are designed to create a secure seal that locks out air and moisture.			
HVBX1000	6 / 152	10 / 254	3 MIL / 75 $\mu$ m	100
HVBX1100	8 / 203	12 / 305	3 MIL / 75 $\mu$ m	100
HVBX1200	11 / 280	16 / 406	3 MIL / 75 $\mu$ m	100



# Global Warranty Coverage



Hamilton Beach Commercial® stands behind its products, and our global warranty coverage and customer service are second to none. If you ever have an issue, we provide fast, friendly service that's available when you need it.

## FOR OUR U.S. CUSTOMERS:



For qualifying products, follow this easy 3 step process:

1. Dial 1-866-285-1087 to speak to a member of our highly trained technical services staff (M-F 8am-5pm EST). We will make an initial phone diagnosis.
2. If it is determined that minimal on-site maintenance cannot be performed, Hamilton Beach Commercial® will ship a replacement product to your location.
3. Once the replacement unit is received, you send the troubled unit back to Hamilton Beach Commercial® (we will provide the box and supporting materials to return the unit and we pay the freight cost for the returned unit).

For all other products, please call 1-866-285-1087 to receive assistance on your parts and labor warranty.

Note: Limitations and exclusions apply. Express Care is only available to end users located in the continental US, Alaska and Hawaii.

## FOR OUR GLOBAL CUSTOMERS:



We have a network of highly trained service companies in over 60 countries worldwide.

We provide 24/7/365 support via our dedicated technical services website which includes:

- detailed troubleshooting and repair instructions
- drawings with exploded view
- recommended parts lists
- registered service centers by country
- operation manuals and agency certifications

Our technical services team, based in North Carolina USA, offers a variety of training options, including web-based training.

Visit us at:

[hamiltonbeachcommercial.com](http://hamiltonbeachcommercial.com) to find your country service provider, contact us directly at +1-910-693-4277 or send an email to: [commercial.support@hamiltonbeach.com](mailto:commercial.support@hamiltonbeach.com).

# Accessories

## Bar Blenders

### 6126-908R

HBB908R series 44 oz./1.3 L polycarbonate container



### 6126-908S

HBB908R series 32 oz./0.95 L stainless steel container



### 6126-255S (120 V)

Rio and HBF510 32 oz. / 0.95 L stainless steel container assembly for HBB255S and HBF510 series



### 6126-255S-CE (230 V)

Rio and HBF510 32 oz./ 0.95 L stainless steel container assembly for HBB255S and HBF510 series



### 98908R

Cutter assembly, clutch and gasket for HBB908R series



### 6126-455 (120 V)

Rio, Tango, HBF510 48 oz./ 1.4 L BPA-free co-polyester container assembly for HBB255, HBH455 and HBF510 series blenders



### 6126-455-CE (230 V)

Rio, Tango, HBF510 48 oz./ 1.4 L BPA-free co-polyester container assembly for HBB255-CE, HBH455-CE, HBF510-CE series blenders



## Commercial Juicers

### UTC960

Under-the-counter pulp bin for HJE960 otto juice extractor series



### 98455

Rio, Tango and HBF510 blender repair kit. Cutter assembly, clutch and gasket for HBB255, HBH455 and HBF510 series



## Back-of-the-House Equipment

### SB961

Stainless steel replacement strainer juice basket and blade for HJE960 otto juice extractor series



### WW800SS

Stainless steel wire whisk for CPM800 series stand mixer



### DH800SS

Stainless steel flat beater for CPM800 series stand mixer



### BW800SS

Stainless steel 8 quart / 8 L bowl with handles for CPM800 series stand mixer



### FB800SS

Stainless steel flat beater for CPM800 series stand mixer



# Covering all the details

## High-Performance Blenders

### HMIA200B

Immersion mixer chopping attachment for HMI200 series



### 990291700

Cutter assembly for HCO500 can opener



### 6126-455 (120 V)

48 oz./1.4 L BPA free co-polyester container for HBB255, HBH455, HBF510



### 6126-455-CE (230 V)

48 oz./1.4 L BPA free co-polyester container for HBB255, HBH455, HBF510 Series



### 6126-600

Fury, Tempest, and Summit 48 oz./1.4 L polycarbonate container assembly for HBH550, HBH650 and HBH850 series blenders



### 6126-650

Fury, Tempest, and Summit 64 oz./1.8 L polycarbonate container assembly for HBH550, HBH650 and HBH850 series blenders



### 6126-750

Eclipse 48 oz./1.4 L polycarbonate container assembly for HBH750 series blenders



### 6126-751

48 oz./1.4 L AirWhip frothing jar compatible with Eclipse and Quantum. Can be used with jar pad JP750 for Fury, Tempest and Expedito 600 Series



### 6126-755

Eclipse 64 oz./2 L polycarbonate container assembly for HBH755 series blenders



### 98650

Tempest, Summit, Revolution & Eclipse blender repair kit with cutter assembly, clutch, gasket, and retainer nut for HBH650 series, HBH755 series, HBH850 series, HBF600/HBF600S series, and HBS1400



### BT650

Tamper for Fury and Tempest and Expedito HBF600 series blenders



### CK650

In-counter kit allows the Tempest HBH650 series to be mounted in counter



### JP750

Alternate jar pad can be used on Fury HBH550, Tempest HBH650, Eclipse HBH755, Summit HBH850, and Expedito HBF600 Series



## Drink Mixers

### Agitators

Adds mixing flexibility and functionality to drink mixers HMD200, HMD300, HMD400, HMD880 and HMD1000 series

**928**



For gently mixing

**929**



For mix-ins and hard ice cream

**930**



For hard ice cream\*

\*Fits models 94950, HMD900, HMD880 and HMD1000

**110E**

Universal 32 oz./.95 L stainless steel container for all drink mixers by Hamilton Beach Commercial



**990156300 (120 V)**  
**990156400 (230 V)**

Replacement motor kit for HMD200 and HMD400 series drink mixers



## Culinary Blenders (Containers)

**6126-510S-CE**

64 oz./1.8 L stainless steel Jar for HBF510S and HBH455 (120 V and 230 V) models



**6126-HBF600S**

Expeditor 64 oz./1.8 L stainless steel container assembly for HBF600 series blenders



**6126-1100S**

Expeditor 1 gallon/4 L stainless steel container assembly for HBF900S and HBF1100S series blenders



**6126-1100**

Expeditor 1 gallon /4 L polycarbonate jar; fits both HBF900S and HBF1100S series blenders



## Culinary Blenders (Kits)

**6126-HBF600**

Expeditor 64 oz./1.8 L polycarbonate container assembly for HBF600 series blenders



**98400**

Expeditor food blender repair kit with cutter assembly, clutch, gasket, and retainer nut for HBF500S series



**98500**

Expeditor food blender repair kit with cutter assembly, clutch, gasket, and retainer nut for HBF500



**981100S**

Expeditor cutter assembly, clutch, gasket, and retainer nut for HBF900S and HBF1100S series



## BigRig™

### HMIS12

12"/305mm shaft  
for BigRig™



### HMIS14

14"/355mm shaft  
for BigRig™



### HMIS16

16"/406mm shaft  
for BigRig™



### HMIS18

18"/457mm shaft  
for BigRig™



### HMIS21

21"/533mm  
shaft for  
BigRig™



### HMI02W

19.5" whisk for  
BigRig™



## Vacuum Packaging

### FP254

Filler plate for HVC254  
series chamber machine



### FP305

Filler plate for HVC305  
series chamber machine



### FP406

Filler plate for HVC406  
series chamber machine



### SB254

Seal bar assembly for HVC254  
series chamber machine

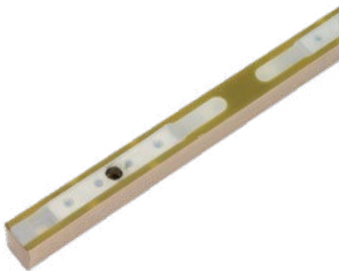

### SB305

Seal bar assembly for HVC305  
series chamber machine

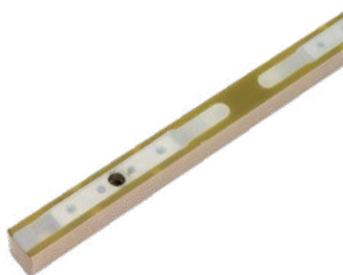

### SB406

Seal bar assembly for HVC406  
series chamber machine

