



Engineered Cleaning Systems for Facilities



CUSTOMIZED CLEANING SYSTEMS

Select from a variety of workstations, floor cleaning systems, dusting systems, surface cleaning systems and specialty cleaning equipment to best address your particular facility needs.

CLEANING FOR HEALTH

Maximum effectiveness in removing dirt from the facility.

USER HEALTH & PRODUCTIVITY

Ergonomic engineering provides maximum user comfort, safety, efficiency and effectiveness.

RELIABLE MANUFACTURER

Filmop, a premier global manufacturer for over 40 years, is respected for its Italian-manufactured products trusted in over 80 countries. Products are manufactured with a unique co-polymer plastic for durability, strength and resilience.



ABOUT FILMOP

PREMIER GLOBAL MANUFACTURER

- Over 40 years of manufacturing expertise in professional manual cleaning equipment
- Market leader in European healthcare facilities and hospitals
- Serving over 80 countries with reliability and efficiency
- Precision manufactured in Italy with quality materials
- Family-owned: flexible, responsive, responsible and focused

Filmop USA Headquarters - Conroe, TX



FILMOP USA

- Headquartered in Conroe, Texas since 2005
- 85,000 square foot facility with over \$3 million in inventory
- Home of Filmop University, an educational and hands-on training facility

CATEGORY LEADERSHIP AND INNOVATION

- Numerous international and domestic patents for cleaning tools and systems
- Co-polymer plastic equipment is strong, light and completely recyclable; an environmentally preferred alternative to metal
- Products are manufactured in Filmop's Italian manufacturing facility that relies on solar and renewable energy
- Intensive engineering focus is placed on user productivity and comfort



FILMOP ADVANTAGES

REDUCES USER INJURY: ERGONOMIC ENGINEERING

DECREASES WORKER'S COMP CLAIMS: Could include OSHA fines, legal fees, worker's pain & suffering costs.



CART HEIGHT +WEIGHT

- 35% lighter than metal
- Clear line of sight, even for shorter users
- Adjustable push handle
- Easy-touch steering



HORIZONTAL LIFT

- Avoids lifting outside the "safe lifting zone"
- Eliminates bag suction for trash and linen collection



ERGO COMPONENTS

- Tools and carts contain various ergonomic components for user safety and comfort

CO-POLYMER MATERIAL = ECONOMIC ADVANTAGES

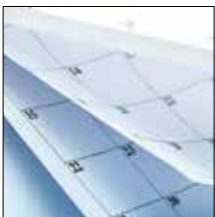

6-10 YEAR LIFESPAN

- Initial investment pays off with longer use and better user ergonomics



REPLACEABLE PARTS

- Interchangeable modules for changing needs
- Can be repaired, replaced & upgraded



CLOSED-CELL CO-POLYMER

- Easier to clean/disinfect
- Resists mold, mildew and bacteria
- Won't rust, dent

CHARGE MOP SYSTEMS (ONE MOP, SINGLE USE)



EQUODOSE MOBILE MICROFIBER CHARGING

- Patented on-demand charging system
- Immediate saturation; choose from 2 - 12 oz. per charge



TOP-DOWN CHARGING BUCKET

- Charges up to 30 mops in 30 minutes
- Uses just 1.5 gallons of cleaning solution



25 DIFFERENT MOP CHOICES

- 2 models: Velcro or Pocket
- 5 different colors
- Long-loop and short nap

WRING MOP SYSTEMS (ONE MOP, MULTIPLE USES)



3 WRINGER OPTIONS

- Side Press: open bottom for maximum rinsing immersion
- High Capacity Down Press
- Punto Roller Wringer



3 DOUBLE BUCKET CONFIGURATIONS

- Alpha Double Bucket: Ride-on Workstation
- Twice: Split Bucket/ Ride-On Workstation
- OneFred: Double Bucket Ride-On or Lift-Off to use



13 DIFFERENT TAB MOP CHOICES

- 5 different colors
- Long-loop and short nap

FLAT MOP ADVANTAGES



54% FASTER

INCREASED PRODUCTIVITY

- Using a microfiber mop is 54% faster than using a traditional string mop¹

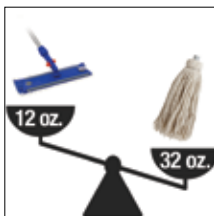

REDUCTION WORKER STRESS

- Wet microfiber = 12 oz. Wet string = 32 oz.²
- Using microfiber mops significantly decreases back, shoulder injury claims³



MOVES DIRT OUT OF BUILDING

- Flat mops maintain consistent contact with surface
- Microfiber holds dirt until laundered (charging system) OR held in rinse bucket until emptied down drain (wringing system)

1. "The Official ISSA 612 Cleaning Times & Tasks," ISSA, compiled by Ben Walker in addition to Filmop internal studies.

2. Ibid

3. "Ergonomics Study of Custodial, Housekeeping, and Environmental Service Positions At the University of California." May 2011. Prepared by the UC System-wide Ergonomic Project Team

FACILITY CLEANING PROGRAM

ALPHA WORKSTATIONS (pg. 6-9, 25-27)

CHARGE MOP SYSTEMS

EQUODOSE® Charging System



Alpha Workstation 55/39
22"W x 55/39"L x 44"H



Alpha Workstation 46
22" W x 46"L x 44"H



Alpha Universal Cleaning Cart 29
22"W x 29"L x 41"H



Alpha Workstation 50 - Enclosed Trash
22"W x 50"L x 44"H

TOP-DOWN® Charging System



Alpha ES Workstation 50 - Dual Supply Tower
22"W x 50"L x 44"H



Alpha Workstation 55/39
22"W x 55/39"L x 44"H



Alpha Universal Cleaning Cart 29
22"W x 29"L x 41"H

WRING MOP SYSTEMS



TWICE Split Bucket Wringing System



ALPHA On-Board Double Bucket Wringing System



OneFred Double Bucket Compact Cleaning Cart *(rides on standard platforms)*





ERGONOMIC, EFFECTIVE CLEANING TOOLS

CHARGING SYSTEM: FLOOR CLEANING

Charging Devices (pg. 13, 30)



Equodose® Mobile Charging
(single use mop)



Top-Down® Bucket Charging
(single use mop)

Mop Models (pg. 15, 31)



Uniko Pocket Mop



Velcro Mop

Mop Heads (pg. 16, 31)



Rapido®



Micro-Fast



Micro-Kleen



Mono-Micro PE100
Disposable



Total Mop with
Velcro Mop Head
(pg. 18, 33)

WRINGING SYSTEM: FLOOR CLEANING

Buckets (pg. 11-12, 28)



Alpha
Double
Bucket



Twice
Split
Bucket



OneFred
Double
Bucket

Wringers (pg. 10, 27)



Side Press



Down Press



Punto Roller

Mop Models (pg. 15, 31)



String Mop



Spin-n-Drop
Tab Mop

Tab Mop Heads (pg. 16, 31)



Rapido®



Micro-Kleen



Micro-Fast

SURFACE / HIGH REACH CLEANING

Hand Trowel (pg. 19, 35)



Hand Trowel



Rapido®



Micro-Fast



Micro-Activa



Microfiber Cloths
(pg. 19, 35)



Dry-Up Absorbent
Disposable Pad (pg. 20, 32)



Spillo Microfiber Duster
(pg. 22, 36)



Snake Bend Spine Microfiber
Duster (pg. 22, 36)



Mono-Wipe TNT50
Dry Disposable
Cloth-Wipes
(pg. 20, 32)

FLOOR CLEANING



Ergo Jobby
Collection (pg. 23, 37)



V-Sweeper® Large
Area Dusting (pg. 17, 34)

CUSTOMIZABLE ALPHA FACILITY WORKSTATION

Start with the industry's most advanced, state-of-the-art workstation base and build a comprehensive, customized cleaning system unique to your needs.



Start with Base Platform

Add Wall & Baskets or Single Supply Tower

Add secondary Supply Tower, Trash Compartment or move Supply Tower to rear and add Trash Bag



CHARGING SYSTEMS

WRINGING SYSTEMS



EQUODOSE® Charging System



TOP-DOWN® Charging System



TWICE Split Bucket

ALPHA On-Board Double Bucket

OneFred Compact (ride-on)



PUNTO 3-IN-1 Adjustable Roller Wringer

Side Press (with open bottom)

High Capacity Down Press

Charging System Mops

Charging OR Wringing System Mop

Wringing System Mops



Pocket Mop



Velcro Mop

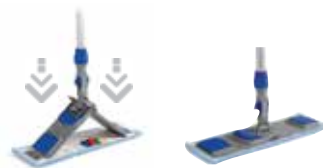

Uni-Tab Pro Universal Mop



Spin-N-Drop® Tab Mop



String Mop

ALPHA ES WORKSTATIONS

"Lego-Like" Customizable Capability



- Interchangeable modules adapt to changing needs.
- Parts can be replaced — no buying a new cart because of one broken part.
- Upgrade or change configuration with ease.
- Detach baskets, shelves, walls for complete disinfection/cleaning.

OPEN OR CLOSED CABINET AND OPEN OR LOCKABLE SUPPLY TOWER DOME



CLOSED, LOCKABLE CABINET AND TOWER TOP



OPEN CABINET AND TOWER TOP

ALPHA ES WORKSTATIONS

Repairable, Replaceable, Expandable

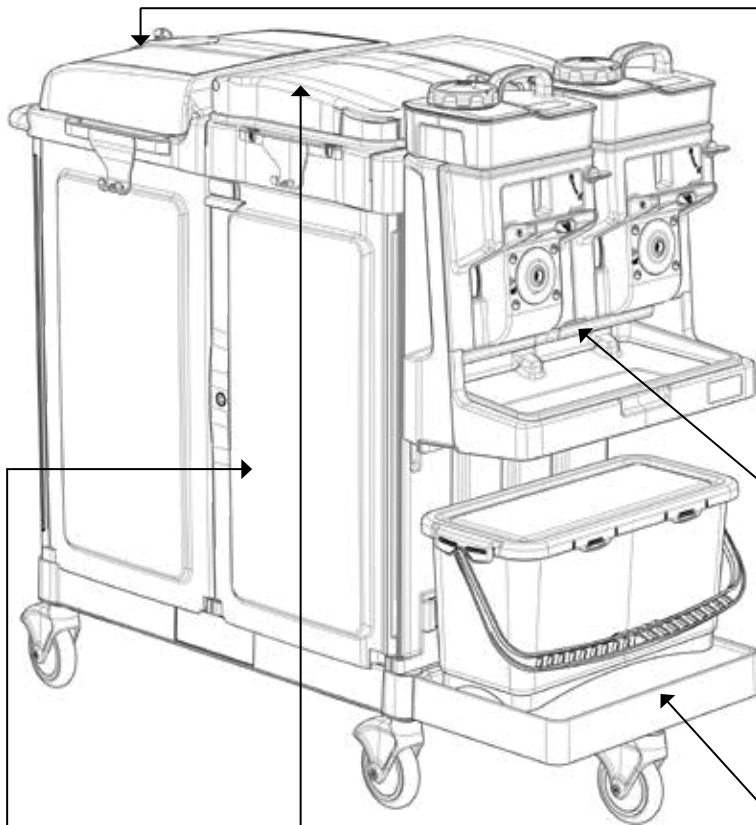

ENCLOSED BAG HOLDER PARTS

27 gallon trash + 13 gallon soiled mop



Cover for 40 gallon bag holder with lockable compartment / check-list holder; gray/blue



Plastic 40 gallon Bag Holder



Divider insert for 40 gallon bag holder



Mesh Laundry Bag w/drawstring closure

EQUODOSE® PARTS



Tray for Equodose



Equodose single or dual tanks, 1.5 gallon, lockable caps



Replacement tanks; EPDM or Viton-B

BASE EXTENSIONS, SIDE BASKET PARTS



10" wide Side Basket.



16.5" Base Extension w/ two non-marking 5" diameter wheels



12.5" Base Extension w/ one non-marking 5" diameter wheels



8.75" Base Small Extension

DOMES & LID PARTS



Dome Frame without lid



Dome Frame w/ lockable lid



Lid for dome with locking mechanism

SUPPLY TOWER PARTS



Platform for lockable drawer, 6 gallon



Multi-purpose slide-out tray



PPE Storage Bin



Drawer w/ or w/out lock, 3 gallon



Drawer w/ or w/out lock, 10.5 gallon



Cabinet Door



Drawer w/ or w/out lock, 6 gallon



Shelves

NOTE: This diagram represents just a sampling of all Alpha Workstation parts.

ALPHA ES WORKSTATIONS



Secure, Lockable 360°



SINGLE KEY PROVIDES SECURITY

1 DOME COVERS



Top locking storage for cleaning chemicals, trash and waste.

2 PULL-OUT DRAWERS



Top drawer lock is standard. Other individual pull-out drawers can be locked (optional).

3 CABINETS



Side locking storage for cleaning chemicals and supplies.

ONE KEY FITS ALL



- Easy, one-key for all lockable areas
- Won't rust, bend or break

NEED MORE SECURITY? ASK ABOUT OUR 8-POINT, 360° LOCKING MODEL



Closed-Cell Co-Polymer vs. Metal



Easy cleaning: Removable parts; no 90° corners



Won't rust



Won't dent



30% lighter than metal



30% quieter than metal



Smart Engineering for Best User Experience



Rounded corners eliminate scratching or catching on clothing.



Height is 44" enabling users a clear view while operating.



Slide-out drawers eliminate excessive bending and reaching. Divider separates soiled mops from trash.



Cabinet opens for removing trash and soiled mop bags horizontally instead of vertical lifting.

WRING MOP SYSTEM: WRINGERS

WRING MOP SYSTEM: Microfiber Mopping System

- Intended for large mopping areas
- Ideal for mopping over an extended period of time
- Use a single mop; eliminates changing mop heads

PUNTO 3-IN-1 ADJUSTABLE ROLLER WRINGER



PATENTED

- 78% less push strength needed to extract water compared to traditional flat press wringer
- Three different wringing settings
- Wringing energy comes from roller
- Press cylinder is dynamic
- Consistent extraction
- Decreased worker fatigue

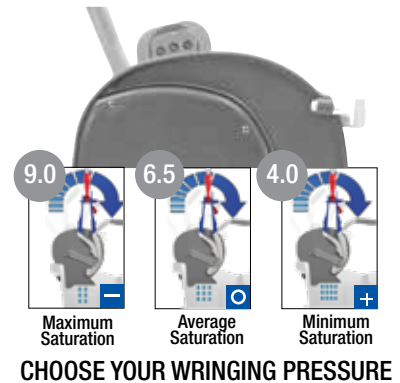

CHOOSE YOUR WRINGING PRESSURE



video ▶

SIDE PRESS WRINGER (OPEN BOTTOM)



- Open bottom allows mop to pass completely through press and into rinse water for thorough rinsing
- Wringing energy comes from user
- Use with Spin-n-Drop Tab Mop or String mop

TWICE FRED ALPHA

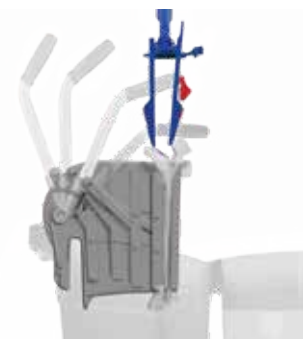

DOWN PRESS WRINGER



- Wringing energy comes from user
- For use with string mops up to 20 oz.

TWICE FRED ALPHA



WRING MOP DOUBLE BUCKET SYSTEMS

TWICE SPLIT BUCKET SYSTEM

TOTAL: 8 gallons
 4.25 gallons: Rinse Water Side
 3.75 gallons: Cleaning Solution Side



SPLIT BUCKET SEPARATES CLEANING SOLUTION FROM RINSE WATER

Cleaning solution stays FRESHER, cleaner, longer

NO LIFTING, SEPARATE BOTTOM DRAINS

Each side drains separately from bottom plug; eliminates lifting

MAINTAINS STABILITY WHILE WRINGING

Engineered to avoid tipping and/or rocking while wringing



PATENTED

ALPHA ON-BOARD DOUBLE BUCKET SYSTEM

TOTAL: 8 gallons
 4 gallons: Rinse Water Side
 4 gallons: Cleaning Solution Side

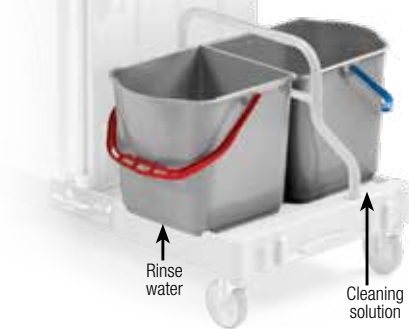

SEPARATE BUCKETS PROVIDE FLEXIBILITY

Carry or empty one bucket at a time

FITS ON STANDARD WORKSTATION PLATFORMS

Enables easy transportation on any standard size platform

MAXIMUM STABILITY STRUCTURE

Firmly holds buckets in place during transport and use.



EFFECTIVELY REMOVES DIRT FROM THE BUILDING



DOUBLE BUCKETS KEEP CLEANING SOLUTION SEPARATE FROM RINSE WATER

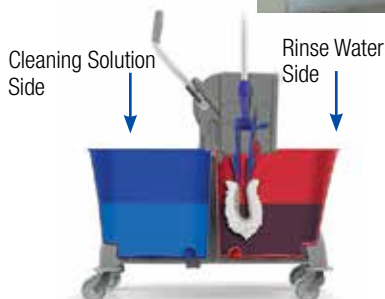

Double buckets keep the cleaning solution completely separate from rinse water.



This preserves the cleanliness of the cleaning solution and prevents dirt from getting spread back on floor.



Dirt in rinse water is removed from the building when bucket is emptied through floor drain, sink or toilet.

WRING MOP SYSTEM: OneFred DOUBLE BUCKET SYSTEM

OneFred DOUBLE BUCKET CLEANING CART

BUCKET OPTIONS



2-4 gallon buckets



2-6.5 gallon buckets



video ▶



shown with floor maintenance accessories

CUSTOMIZE BY WRINGER AND BUCKET CAPACITY

Choose from three different wringers and two different bucket capacities for use on the same OneFred frame.

SELF-CONTAINED SYSTEM

Accessorize to have all floor maintenance essentials contained in single, small mobile system.

COMPACT SIZE

OneFred frame has compact footprint of 25.5" x 15.3". Fits for transport on standard full-size cart platforms.

NO-TIP ENGINEERING

Engineered for perfect balance for no-tip, secure stabilization, whether in use or during transport.

EASY TRANSPORT / USE WHILE ON CART



Fits on standard full-size carts for transport

USE SEPARATELY FROM CART



Remove from cart platform and roll to exact cleaning location.

NIMBLE, LIGHTWEIGHT



Weighs just 12.4 pounds with 360° swivel wheels with integrated bumpers.

COMPACT STORAGE



Carriers and buckets stack for space-saving storage.

DETACHABLE BASKET



Use with or without Carry-all Basket.

CHARGE MOP SYSTEMS

CHARGE MOP SYSTEM: Microfiber Mopping System

- Intended for frequent mop head changes for maximum cross-contamination control
- Ideal for mopping individual rooms (one mop per room) or areas up to 250 sq. ft.
- Most effective process for capturing, holding and removing dirt from building
- Charging systems eliminate transport of heavy mop buckets
- More consistent saturation

EQUODOSE® SINGLE MOP, MOBILE CHARGING SYSTEM



ON-DEMAND, RAPID, FLEXIBLE CHARGING

- Charge mops and/or cleaning cloths as needed
- Set desired saturation amount
- Consistent saturation

USE CLEAN, DRY MOPS & CLOTHS

- Easy & fast spill clean-up
- Can use for dry dusting (if desired)
- Charge for wet/ damp mopping/ cleaning

CONSERVE RESOURCES

- Refillable, sealed tanks don't waste chemicals
- Easy re-stocking of unused mops & cloths
- Less weight to carry = decreased worker strain



video ▶

POCKET MOPS

VELCRO MOPS

TOP-DOWN® MULTI-MOP BUCKET CHARGING SYSTEM



PRE-MOISTENS MICROFIBER MOPS IN 30 MINUTES

- Up to 30 microfiber mops charged at one time
- Uses just 1.5 gallons of cleaning solution
- Ready to use in 30 minutes
- No trips to water source
- No touch, no wringing



video ▶

POCKET MOPS

VELCRO MOPS



MICROFIBER MOP MODEL OPTIONS

ERGOSWING Ergonomic Flat Mop Mopping System

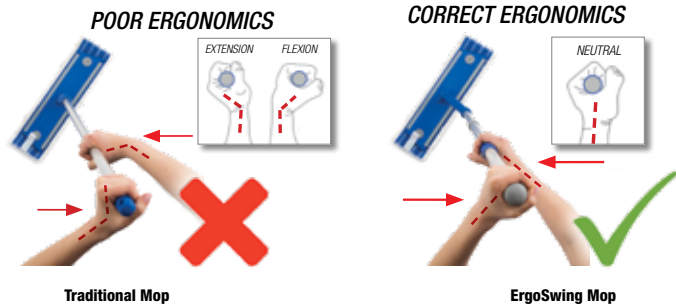

Two Swivel Hand Grips = Correct Ergonomics: Swivel grips easily swing the handle and mop in a figure-eight motion while allowing for optimum wrist, arm and body alignment, critical to preventing Musculoskeletal Disorders (MSDs).

UNI-TAB PRO: USE WITH VELCRO, POCKET OR TAB SYSTEM

COMPLETELY NEW APPROACH TO FLAT MOPPING: One Mop for Velcro, Pocket or Tab Systems

WRING OR CHARGE

VELCRO



POCKET



TAB



NO TOUCH ATTACH
(Slip & Click)



SLIP & CLICK FOR MOPPING:



Uniquely engineered tabs located on the sides of the Uni-Tab Pro mop head easily slip into slots on the Uni-Tab holder, automatically clicking into place and locking securely until released.

NO TOUCH RELEASE
(Pinch & Drop)



STEP TO COLLAPSE:



Stepping on the release button located on the top of the Uni-Tab holder collapses it for wringing.



PUNTO ROLLER



SIDE PRESS



EQUODOSE



TOP-DOWN

MICROPLAST MICRO-LOOP MOP (Charge Mop System or Dry Dust)

CHARGE

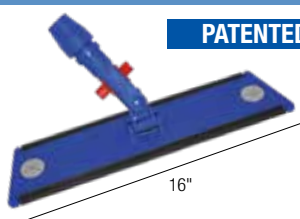

PATENTED

Preserves Velcro Integrity: Prevents fibers, threads and other debris from sticking, clogging, and interfering with adhesion capability.

Microscopic Loops: Quick hold and easy release of Mono-Micro Disposable Microfiber Pads.

Usage Flexibility: Use with Mono-Micro Disposable Pads or add Quik-Stik Daily Dusting Wipes and secure with star-keeper tabs for dry dusting.



Microplast Velcro Strips



Conventional Velcro Strips

MICROFIBER MOP MODEL OPTIONS

SPIN-N-DROP® TAB (Wring Mop System)

WRING



PATENTED

Easy Tab Attachment: Mop head is securely attached to frame with plastic, locking hooks and clamping mechanism.

Foot Activated Collapsing: Mop holder collapses with foot activation; locks in open position when placed on floor.

Converts from flat mop to wringable mop



PUNTO ROLLER



SIDE PRESS



video ▶

MICROFIBER STRING (Wring Mop System)

WRING



Superior Stitching / Microfiber: Made with superior stitching and microfiber material, captures and holds dirt until released in wash.

Easy-lock Mop Head Attachment: Durable, easy to lock and unlock mop head.



DOWN PRESS



SIDE PRESS

UNIKO® POCKET MOP (Charge Mop System)

CHARGE

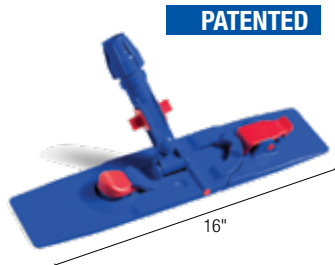

PATENTED

Patented Locking System: Easy-slide locking system for vertical cleaning.

Patented No Touch: Mop head secures into place with downward pressure. To disengage, one side of mop is released as holder collapses with foot activation. The other side is released over dirty mop receptacle with push of button.



video ▶



EQUODOSE



TOP-DOWN

Release button prevents touching soiled mop head



VELCRO MOP (Charge Mop System)

CHARGE

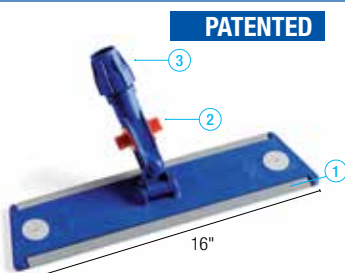

PATENTED

Patented Locking System: Vertical cleaning is simplified with the easy-slide locking system.

No Touch: Mop head is engaged with pressure; can be disengaged with feet and collected for disposal with grabber tool.

Replaceable Velcro Strips: Strips are easily removed for fast replacement.



Easy grip-and-pull motion for replacing Velcro strips. No cumbersome screws or complicated process.

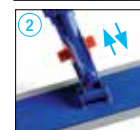

Sliding mechanism locks for vertical cleaning, unlocks for swivel floor cleaning.



No metal parts! Made with light-weight, shock-proof, durable co-polymer material.



EQUODOSE



TOP-DOWN

MICROFIBER FLAT-MOP HEADS

RAPIDO® Long-Loop Mop

POCKET

VELCRO

TAB



FILAMENT STRUCTURE:
100% Extruded Blend Microfiber
(80% Polyester, 20% Polyamide)

Color Code:
Mop-Side: Solid White, Yellow, Red,
Blue, Green ○ ● ● ● ● ●
Back-Side: Velcro: Solid colors ■ ■ ■ ■ ■ ■
Pocket & Tab: Solid White □



Guaranteed Wash Cycles: 600
Pictured: Velcro

MICRO-FAST Long-Loop Mop

POCKET

VELCRO

TAB



FILAMENT STRUCTURE:
100% Twisted Blend
(70% Polyester Microfiber, 25% Polyester, 5% Rayon)

Color Code:
Mop-Side: Blends-White/Yellow, White/Red,
White/Blue, White/Green, White/Purple
Back-Side: Color-coded ribbing □ □ □ □ □ ● ● ● ● ● ●
White/Purple: 4-color tag ■ ■ ■ ■



Guaranteed Wash Cycles: 400
Pictured: Velcro

MICRO-KLEEN Long-Loop Mop

POCKET

VELCRO



FILAMENT STRUCTURE:
100% Twisted Blend
(80% Polyester Microfiber, 20% Polyester)

Color Code:
Mop-Side: One-color Blend: White/Gray ○ ●
Back-Side: Blue ribbing □



Guaranteed Wash Cycles: 300
Pictured: Pocket

MICRO-ACTIVA Short-Loop Mop

POCKET

VELCRO

TAB



FILAMENT STRUCTURE:
100% Extruded Blend Microfiber
(85% Polyester, 15% Polyamide)

Color Code:
Mop-Side: Blue ● ● ● ● ● ●
Back-Side: Four-color tabs ■ ■ ■ ■



Guaranteed Wash Cycles: 200 - 250
Pictured: Tab

MONO-MICRO PE100 DISPOSABLE Microfiber Mop

VELCRO

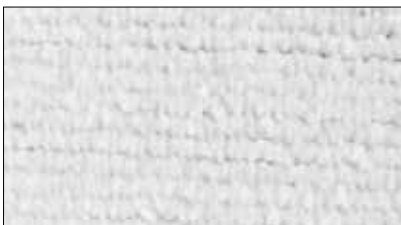

FILAMENT STRUCTURE:
100% .5 denier Polyester Microfiber

Color Code:
Mop-Side: White
Back-Side: White-ribbed
Both sides will adhere to Velcro holders



Measures 18.5" x 5"
Use with Velcro Holder - 16" or 18"

MICROFIBER FLAT-MOP FLOOR CLEANING

PULI-SCRUB Scrubbing Mop

TAB

FILAMENT STRUCTURE:

70% Extruded Blend Microfiber
(70% Polyester, 30% Polyamide)
30% Polypropylene (for scrubbing)

Color Code:

Mop-Side: Blue ●
Back-Side: Four-color tabs 



MCP Mop

TAB

FILAMENT STRUCTURE:

43% Microfiber
(80% Polyester, 20% Polyamide)
24% Cotton, 33% Polyester

Color Code:

Mop-Side: White/Green/Beige 
Back-Side: White □



V-SWEEPER® Large Area Floor Dusting System



- Expands to a full 58" or 72" then narrow for smaller spaces
- Scissor-type action gathers and holds debris and dust in the center of the v-shaped frame



video ▶

RAPIDO

MICRO-FAST



LAMELLO Rubber Blade Duster with Quik-Stik Wipes



Easy slide. No residue.
No drag.

- LaMello replaces foam-based products which can harbor bacteria
- Autoclavable, squeegee-type blades are strategically spaced for extraordinary capture of dust, dirt and debris
- Flexible rubber blades capture and hold dust, dirt, and debris
- Ideal for uneven surfaces as well as smooth flooring



Use with Quik-Stik Disposable Daily Dusting Wipes



STEP 1: Tear off three 6" sections of Quik-Stik Dust Wipes



STEP 2: Wrap around LaMello and secure using star keepers

FLOOR DUSTING Systems

Velcro Frame Floor Dusting

STANDARD CONNECTOR



- Made with light-weight and durable co-polymer with standard connector
- Available in 24", 32" and 40"

RAPIDO

LOCKING CONNECTOR



- Features locking connector to stabilize holder for vertical use
- Available in 24", 32" and 40"

MICRO-FAST

Key Hole Floor Dusting



- Fits all standard key-hole frames
- Highly efficient looped microfiber construction
- Available in: 18", 24", 36", 48", 60", 72"

FLOOR SPECIALTY CLEANING SYSTEMS

TOTAL MOP® Bucketless Microfiber Mop System



16"

- No bucket, no wringer
- Color-coded, easy snap-on solution containers
- Ideal for stairs and uninterrupted cleaning
- Simple, one-touch solution control system
- Easy-maneuver swivel frame



Side Dispensing: Activated by depressing button on handle side



Top Dispensing: Activated by depressing button on top of handle



video ▶

TOTAL MOP QUICK CHANGE

Total Mop bucketless cleaning system complete with 22 oz. or 34 oz. removable, quick change tank

VELCRO MOPS

POCKET MOPS



Color coded removable container



TOTAL MOP ON-BOARD

On board container with fewer movable parts = hassle-free application

VELCRO MOPS

Total Mop bucketless cleaning system complete blue

- 50 oz. tank
- TOP dispensing knob
- Velcro system



SPRINTER FILL 'N FLOW HANDLE

Cleaning solution stored in handle for tubeless, consistent dispensing. Use with Velcro mop system.

- 17 oz. capacity
- TOP dispensing knob
- Velcro mop holder



FLAT MOP & BUCKET FINISH System



- Plastic frame has no metal parts
- Mop heads specifically manufactured for floor finish application with viscose/polyester cut fibers
- Mop head attaches to frame with plastic hooks to eliminate premature Velcro replacement
- Mop head launders easily to remove floor finish residue
- Floor finish bucket transports easily; co-polymer sieve prepares mop head with appropriate amount of floor finish



SURFACE CLEANING SYSTEMS

BRILLIANT Glass & Shine Surface System

Streak-free, brilliant results with fewer passes and less effort. On average, 20% fewer passes as compared to competitors.



Use with Micro-Activa microfiber pads for outdoor high-reach cleaning

KNITTED MICROFIBER

Knitted microfiber material on thin, flexible backing provides exceptional dirt capture and hold without disruptive drag.

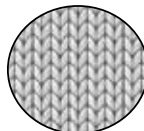

DURABLE: 100 WASHINGS

Can be washed up to 100 times without compromising performance.

LIGHT-MIST PREP

No need to saturate surface or pads. Use a fine-mist of cleaning solution on pad for best results.

EXTRUDED BLEND CONTENT

Made with extruded blend microfiber comprised of 80% polyester, 20% polyamide microfiber.

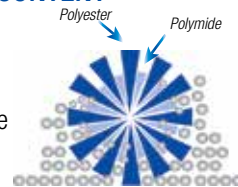

NYLON HOOK BACKING with REPLACEABLE STRIPS

More durable than Velcro, this backing eliminates premature wear, tear and loss of grip. Pad holder replacement strips available.



Velcro Rapido



Velcro Micro-Fast



Velcro Micro-Activa



video ▶

MICROFIBER Hand TROWEL Flat Surface Cleaning System



- Covers more area in less time than cloths
- Provides constant contact with surface
- Reduces wrist strain
- Easy-change, secure Velcro microfiber pad attachment

12" 16"



video ▶

Velcro Rapido



Velcro Micro-Fast



Velcro Micro-Activa



Velcro Mono-Micro PE100 Disposable



MICROFIBER Cloths



MULTI-PURPOSE MICROFIBER Cloths

Suitable for any surface, any environment

- Available in 12" x 12" and 16" x 16"
- Holds 4x its weight
- Made of 80% polyester, 20% polyamide microfiber
- Machine washable up to 200 washings



Color-coded for reducing cross-contamination

DISPOSABLE SYSTEMS

MONO-WIPE TNT50 Dry Disposable Cloth-Wipes

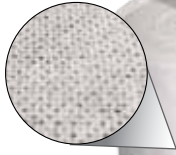

THICK, LONG-LASTING DISPOSABLE Cloth-Wipes

Wipes Farther, Keep Surfaces Wet Longer

- Remarkably durable. Won't rip, tear or break-down. Measures 11" x 12.5".
- Won't mold, mildew. No paper filler. Comprised of 65% rayon, 35% polyester.
- Outlasts smaller, non-cloth-like wipes. Each wipe holds up to 1.5 ounces of liquid.
- Choose your soaking solution. Use 2-3 quarts to moisten one roll.
- No discernable quat binding, even after 24 hours.

HAND-WIPE



ONE SHEET



SPILO FLEX SPINE



TWO SHEETS



24 hours

Shows no discernable quat absorption from zero hour to 24 hours.



Tested by Standard for Evaluating Wipes-EN 16615:2015 (4-field test) with efficacy up to 90 days. No mold, no mildew.



Co-polymer, heavy-duty dispenser is reusable. It features the Slide-n-Seal top to keep wipes moist.



Folded into quarters, still easily fits in a hand with impressive bulk for best wiping action.

DRY-UP Disposable Liquid Absorbing Pad



Absorption Layer = Converts Liquid to Gel



Waterproof Top Sheet = Protects User; No Drip, No Leak

Uses a unique absorbing polymer and Clean-Capture™ Technology

FAST, NO DRIP ABSORPTION

Absorbs liquid in seconds, bonding it into the pad.

HYGIENIC FOR USER

Waterproof top layer protects the user from touching the substance.

ABSORBS UP TO 4 CUPS OF LIQUID



Disposable MICROFIBER STRING MOP



Latex-free, holds up to approximately 5.5 cups of liquid.

ABSORBS 1/3 MORE THAN TRADITIONAL COTTON

Measures 16" in length. Can absorb up to about 5.5 cups of liquid.

LOW-LINT, LIGHTWEIGHT

Weighs just 9 ounces (dry). Comprised of a polyester, cellulose blend.

DISPOSABLE SYSTEMS

QUIK-STIK Disposable Dust Technology



NEW!
Glue-Infusion
Technology

Quik-Stik products are made with innovative glue-infusion technology.

CAPTURES AND HOLDS DAILY DUST, HAIR

Made with unique glue-infusion technology, Quik-Stik dusting products pick-up and hold dust and hair until thrown away.

LEAVES SURFACES RESIDUE-FREE

Won't leave behind residue on surfaces or on hands.

INFUSION = ECONOMY + EFFICACY

Glue-infusion technology provides a more effective dry dusting materials at a fraction of the cost of a glue coating process.

QUIK-STIK WIPES

Perforated in 6-inch increments; tear the length you need to fit your tool. Can be used manually, with LaMello Rubber Blade Duster or with Spillo Flex-Spine Duster.

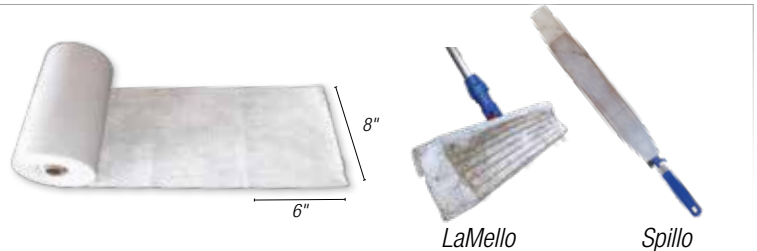

QUIK-STIK SLEEVES

Available in 18" and 24" length. Can be used with Spillo Flex-Spine Duster or Snake Bend-Spine Duster.

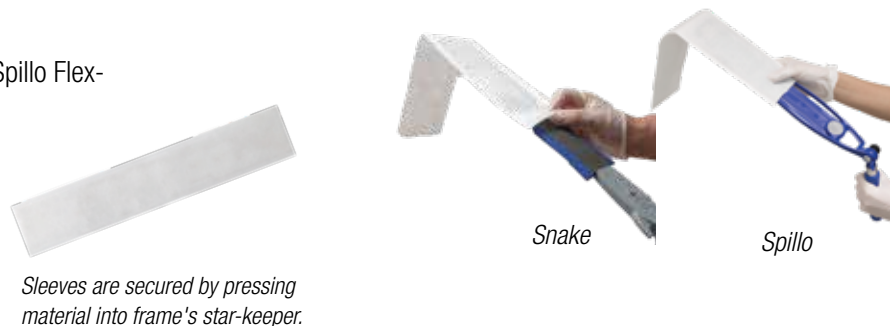

Sleeves are secured by pressing material into frame's star-keeper.

MONO-MICRO PE100 Disposable Microfiber Mops



40% more absorption

100% Microfiber absorbs up to 40% more cleaning solution than competitors.

EASILY ABSORBS 4.5 OUNCES

Quickly and easily absorbs 4.5 ounces of cleaning solution compared to other disposable microfiber mops which absorb 2 - 3 ounces.

MORE CLEANING PER MOP

Since more solution is absorbed into the mop head, there is more square feet of mopping distance.

100% MICROFIBER

No fillers. No strips. Mono-Micro PE100 is 100% .5 denier polyester (PE) microfiber, edge-to-edge, through and through. Microfiber strands are more effective in removing dirt and microbials from floor surfaces compared to other textiles.

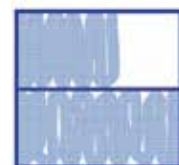

Brand X

FLMOP
EQUIPMENT & SUPPLY

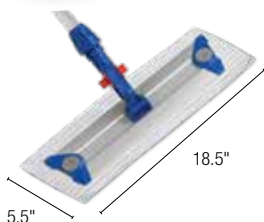

SURFACE AND HIGH LEVEL CLEANING

SNAKE Bend Spine Dusting System



THIN, FLAT PROFILE FOR TIGHT CREVICES

Use flat to reach into areas where fluffy dusters just can't get into!

EASILY BENDS, FIRMLY HOLDS SHAPE

Angle and shape the Snake frame to conform to the surface.

FRAME PADDING ADDS CUSHION

Better cushioning provides superior surface contact & maximum cleaning performance.

DURABLE CO-POLYMER MATERIAL

Co-polymer material is durable, metal-free, light-weight and easy to clean. Won't rust or dent.



16" & 24" Snake Bend Spine Duster



Quik-Stik Disposable Dusting Sleeve



Micro-Fast Microfiber Long Shag Sleeve



SPILLO Flex Spine Dusting System



RIGID, PRESSURE ACCEPTING FRAME

Maintains contact on flat, hard-to-reach surfaces, even when pressing hard.

LOCKS INTO ANY ANGLE

Frame can be locked into any angle by simply pressing a button.

FITS INTO TIGHT SPACES

Frame measures less than 1/8" in depth for easy access to tight crevices and spaces.



DURABLE CO-POLYMER MATERIAL

Co-polymer material is light-weight, easy-to-clean. Won't rust or dent.



16" & 24" Spillo Flex Spine Duster



Quik-Stik Disposable Dusting Sleeve



Micro-Fast Microfiber Long Shag Sleeve



Spillo can also be used with Quik-Stik Disposable Daily Dusting Wipes



Wrap Quik-Stik Wipes around frame and secure

FLOOR COLLECTION SYSTEMS

ERGO JOBBY Collection System



Effectively captures liquid or dry debris

Quick, controlled clean-up of liquids, solids and dust.

- Collection pan snaps upright for secure holding of waste
- Ergo handle locks upright during use; snaps down for transport on workstation
- Squeegee enables effective collection of liquids
- Traditional brooms can also be used with Jobby



Foldable Ergo Handle



Razor-thin rubber edge lays flat to floor to eliminate "back-and-forth" collection. Slight curvature holds debris towards back of pan.



Also available with broom

ERGO BAGGY Collection System



Use with the bag of your choice



No-touch, fast, hygienic clean-up of wet and dry debris.

- Collects solid and liquid debris
- No-touch system; easy disposal of waste
- Use disposable bag of your choice, according to need
- Easy to clean & disinfect
- Replaceable rubber blade profile



Open design = Easy clean & disinfect

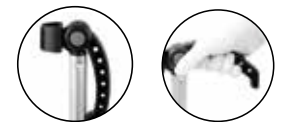

Foldable Ergo Handle



Large items fit through sides



Move bag clip on handle to accommodate chosen bag size. Pull bag up to secure on bag clip holder and make any additional adjustments for securing.

Features: Filmop Floor Collection Systems



One-sweep collection. Rubber edge lays flat to floor, flexible squeegee blade bends to eliminate gaps.



Swivel squeegee head reaches into tight places.



No more broom bristles. Squeegee wipes clean and can be disinfected between uses.



Replaceable rubber blades on pan profile edge and squeegee.

COLLECTION SYSTEMS

DELTA MULTI-COLLECTION System



Light-weight, agile, multi-purpose container for collection and transportation of dirty linens, trash, or other waste.

- Color-coded covers activated by foot pedal (no touch)
○ ● ● ● ● ●
- Quiet and easy to maneuver with polymer wheels; eliminates bulk & weight
- Use bag of your choice (32 gallon capacity, 18" diameter opening)
- Can be converted to abbreviated cleaning cart with basket holding cleaning necessities



Features Tuck-n-Snap Bag Holding System

POLARIS 24-GALLON STEP-ON TRASH BIN

- No-lift, ergonomic bag removal avoids lifting outside the "safe lifting zone" and eliminates bag suction
- Built-in deodorant holder and closed cover helps to contain odors
- Safe, easy transport with ergonomic handle and 4" co-polymer wheels

POLARIS BASIC

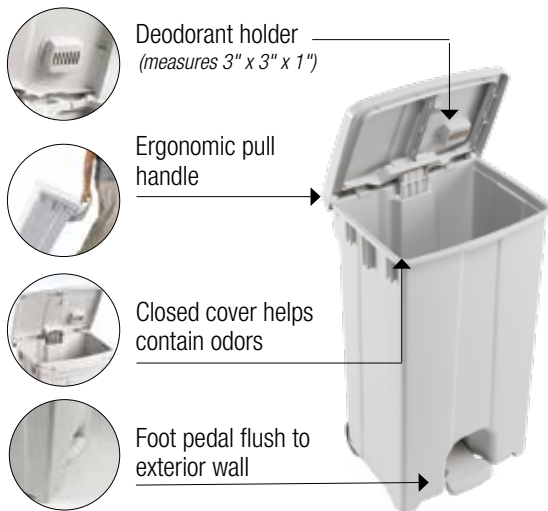

POLARIS DELUXE

Features of Polaris Basic plus:

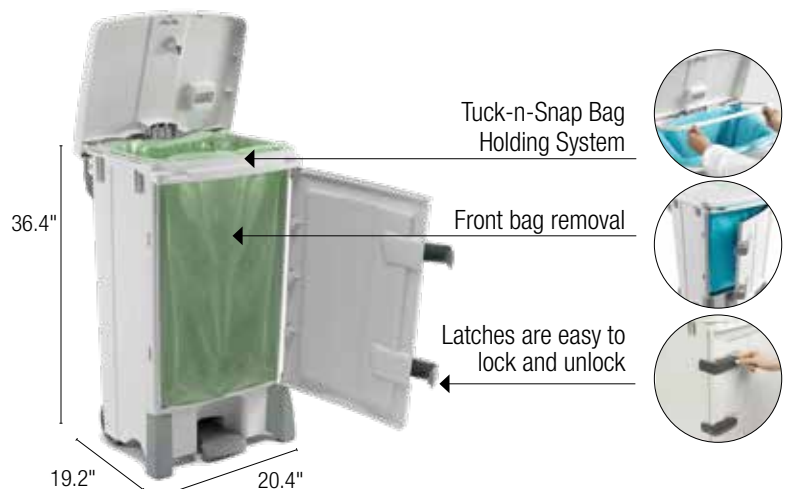

Polaris Basic and Polaris Deluxe made with co-polymer construction: easy to clean, sturdy, light-weight and won't rust.

PRODUCT DETAILS

EQUODOSE MOBILE MICROFIBER CHARGING WORKSTATIONS (ON-DEMAND SINGLE MOP)



Alpha ES Workstation 55/39 Complete

22"W x 55/39"L x 44"H
1 Equodose tank (1.5 gal), 1 tower (A), 21 gal. trash foldable bag, 1-16" blue bucket for dry mops, 5" wheels.
Item# **AA1607706U001**

Double Tank Equodose

Item# **AA1607705U001**



Alpha ES Workstation 50 Complete

22"W x 50"L x 44"H
1 Equodose tank (1.5 gal), 1 tower (A), enclosed 40 gallon trash collection, 1-16" blue bucket for dry mop transport
Item# **AA1807706U002**

Double Tank Equodose

Item# **AA1807707U002**



Alpha ES Workstation 46 Complete

22"W x 46"L x 44"H
1 Equodose tank (1.5 gal), 1 tower (A), 1 removable side basket, 1-16" blue bucket for dry mops, 1-16" red bucket for soiled mops.
Item# **AA3607726U001**

Double Tank Equodose

Item# **AA3607727U001**

Trash configurations



Foldable Bag
21 gal. trash +
11 gal. soiled mops



Enclosed
27 gal. trash +
13 gal. soiled mops

Tower configuration



A



B



Alpha Cleaning Cart 29 Complete with Equodose Mobile Microfiber Charging System

22"W x 29"L x 41"H
1 Equodose tank (1.5 gal.), 1-16" blue bucket for dry mops, 1-16" red bucket for soiled mops, ergonomic push handle, two (2) removable baskets (internal measurements: 8.75"L x 19.5"D x 4.65"H)
Item# **MA0117708U001**

TOP-DOWN BUCKET CHARGING WORKSTATIONS (MULTI-MOP CHARGING)



Patient Room Alpha ES Workstation 50 Complete

22"W x 50"L x 44"H
2 towers (A-front & B-back), no trash; 1-10" wide hanging basket, 1-16" blue bucket for charged mops (5 gal), 1-16" red bucket for soiled mops (5 gal), 5" wheels.
Item# **AA1607702U001**



Alpha ES Workstation 55/39 Complete

22"W x 55"/39"L x 44"H
1 tower (A); foldable trash collection (21 gal.); 1-16" Top-Down Charging Bucket
Item# **AA1607708U001**



Alpha Cleaning Cart 29 Complete with Top-Down Charging System

22"W x 29"L x 44"H
Top-Down blue bucket for charged mops, red bucket for soiled mops, ergonomic push handle, two (2) removable baskets (internal measurements: 8.75"L x 19.5"D x 4.65"H)
Item# **MA0117703U003**

PRODUCT DETAILS

WORKSTATION BASES



General Cleaning Alpha ES 55/39
 22"W x 55"-39"L x 44"H
 1 tower w/ lockable sliding drawer (6 gal) w/ organizer, 1 adjustable shelf, foldable trash bag (32 gal.), 1 Easy Accessory Hanging Kit, 5" wheels
 Item# **AA1607000U011**



Common Area Alpha ES 55/39
 22"W x 55"-39"L x 44"H
 1 sliding drawer w/o lock (3 gal), 1 set shelves, foldable trash (32 gal), 1 Easy Accessory Hanging Kit, 4" wheels
 Item# **MA1643000U012**



Alpha Cleaning Cart 29 Complete
 22"W x 29"L x 41"H
 Ergonomic push handle, two (2) removable baskets (internal measurements: 8.75"L x 19.5"D x 4.65"H)
 Item# **MA0117003U006**



Alpha Workstation 46
 22"W x 46"L x 44"H
 1 tower w/ lockable sliding drawer (6 gal) w/organizer, 1 sliding drawer (6 gal), 1 Easy Accessory Hanging Kit, 5" wheels
 Item# **AA1607015U001**



Alpha ES Workstation 59
 22"W x 59"L x 44"H
 2 supply towers: Front-1 lockable 6 gal. sliding drawer w/organizer, 1 6 gal. sliding drawer; Rear-2 adjustable shelves, 1 slide-out tray; 1 Easy Accessory Hanging Kit, 5" wheels
 Item# **AA1607010U001**

ALPHA EASY ACCESSORY HANGING KITS

ENCLOSED TRASH KIT

ITEM# **0000SM00284**



1- 4 1/4" Hanging Bar for Dome
 Item# **P1919969U**



2- 5 1/2" Hanging Bars for 40 gal. bag holder
 Item# **P1929969U**



4- UNI-Move Tool Hangers
 Item# **0000SM00250U**

FOLDABLE TRASH BAG KIT

ITEM# **0000SM00290**



1- 3.5" Base Extension
 Item# **P165001U**



4- UNI-Move Tool Hangers
 Item# **0000SM00250U**



1- 1" Accessory Hanging Bar
 Item# **P1909901U**



1- 4 1/4" Hanging Bar for Dome
 Item# **P1919969U**



1- 4 1/4" Accessory Hanging Bar w/o Floor Sign Holder
 Item# **P1909958U**

PRODUCT DETAILS

WRINGING SYSTEMS COMPLETE

ALPHA On-Board Double Bucket System



Common Area Alpha ES 55/39 On Board Double Bucket
 26"W x 55-39"L x 44"H
 2x4 gal buckets, 1 side press wringer, 1 tower (B), trash collection foldable bag 32 gal., 1 Easy Accessory Hanging Kit, 5" wheels
 Item# **AA1607400U012**

Trash configurations		Tower configuration	
Foldable Bag 21 gal. trash + 11 gal. soiled mops	Enclosed 27 gal. trash + 13 gal. soiled mops	A	B

OneFred Double Bucket Compact Cleaning Cart *(rides on standard platforms)*



Common Area Alpha 39 with Ride-On OneFred
 29"W x 39"L x 44"H
 1 tower (B), OneFred Ride-On Double Bucket w/Side Press, 2-UNI-Move Tool Hangers, 4" wheels
 Item# **AA3617419U001**



Common Area Alpha 29 Complete with Ride-On OneFred
 29"W x 29"L x 41"H
 OneFred Ride-On Double Bucket w/ Side Press, 2 side baskets, 2 UNI-Move Tool Hangers, 4" wheels
 Item# **MA0117402U006**

WRINGERS



Side Press Wringer, open bottom
 Item# **7002U**



Extra Capacity Down Press Wringer w/ handle
 Item# **60758004A/1**



3-in-1 PUNTO Adjustable Roller Wringer, blue, medium saturation setting
 Item# **14000U**

BUCKETS



Double Buckets, 4 gal. with handle
 Item# **0000SE0115UA** ●
 Item# **0000SE0115UB** ●

ALPHA

ONEFRED



Double Bucket, 6.5 gal. with handle
 Item# **0000SE0125UA** ●
 Item# **0000SE0115UB** ●

ALPHA

ONEFRED



Wringer support for Alpha double bucket on-board system
 Item# **R1040010**

ALPHA

PRODUCT DETAILS

TWICE DUAL BUCKET SYSTEMS: COMPLETE (ride-on)

PUNTO ROLLER WRINGER



Punto Wringer and Twice split bucket, gray
 Item# **0331SL2800U** ●
 Item# **0351SL2800U** ●
 Item# **0352SL2800U** ●
 Item# **0353SL2800U** ●
 Item# **0354SL2800U** ●

SIDE PRESS WRINGER



Side Press gray and
 Twice split bucket; red
 Item# **0361SL2800B**



Side Press gray and
 Twice split bucket; gray
 Item# **0361SL2800U**

ALPHA DOUBLE BUCKET SYSTEMS: COMPLETE (ride-on)

PUNTO ROLLER WRINGER



Alpha double bucket (2- 4 gallon
 buckets) with Gray Punto Wringer
 Item# **KIT008**

SIDE PRESS WRINGER



Alpha double bucket with gray Side Press
 Wringer
 Item# **KIT011** (2- 4 gal. buckets)
 Item# **KIT013** (2- 6.5 gal. buckets)

DOWN PRESS WRINGER



Alpha double bucket (2- 4 gallon buckets)
 with Down Press Wringer (blue)
 Item# **KIT012**

OneFred DOUBLE BUCKET SYSTEMS



OneFred Double Bucket Cart with
Punto roller wringer
 2-6.5 gallon buckets
 Item# **0531LF0050YU**



OneFred Double Bucket Cart
 with **Side Press wringer**
 2-6.5 gallon buckets
 Item# **0561LF0050YU**



OneFred Double Bucket Cart
 with **Down Press wringer**
 2-6.5 gallon buckets
 Item# **0536LF0050YU**

PRODUCT DETAILS

OneFred DOUBLE BUCKET SYSTEM



OneFred Double Bucket Cart Complete with **Side Press wringer**, 2-6.5 gallon buckets, 32" - 55" telescopic handle, Carry-All Basket, folding Spin-n-Drop tab mop holder, 2 microfiber tab mop heads
Item# **0561LF0050YU1**



OneFred Buckets - 6.5 gallon
Item# **0000SE0125UA** ●
Item# **0000SE0125UB** ●
4 gallon
Item# **0000SE0115UA** ●
Item# **0000SE0115UB** ●

Ergonomic Handle
Item# **8731Y**



Carry-all Basket for holding supplies. Co-polymer material. Measures 10.75" W x 4.25" D x 5" H
Item# **60406Y**



OneFred Frame
Item# **08730Y**



Mop Holder Support Kit: 2 supports, 1 UNI-Move Tool Hanger, 1- 1" hanging bar
Item# **0000SM00303**

ALPHA WORKSTATION ACCESSORIES

DRAWERS, SHELVES, MISC.



12.5" base extension w/ 1 non-marking 5" wheel
Item# **P075030U**



Drawer w/out lock, 3 gal.
Item# **P1229909U**



Lockable drawer, 3 gal.
Item# **P2229909U**



Platform for P2229906U, lockable drawer, 6 gal.
Item# **P1909937U**



4" pirouetting wheel, non-marking
Item# **23011262**



4" pirouetting wheel w/brake, non-marking
Item# **23011272**



5" swivel ball bearing wheel, co-polymer
Item# **24011298**



5" swivel ball bearing wheel w/ brake, co-polymer
Item# **24011299**



5" swivel ball bearing wheel, co-polymer for 12.5" extension
Item# **34011274**



8.75" base extension
Item# **P165000U**



Drawer w/out lock, 3 gal.
Item# **P1229906U**



Lockable drawer, 6 gal.
Item# **P2229906U**

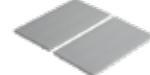

Shelf, 2 pieces.
Item# **P1229900U**



3.5" base extension
Item# **P165001U**



Drawer w/out lock, 10.5 gal.
Item# **P1229907U**



Lockable Drawer, 10.5 gal.
Item# **P2229907U**



Multi-purpose slide-out tray
Item# **P3229915U**

BASKETS, BUCKETS & BAGS



Microfiber Cloth Charging Bucket, 1 gal., colored handles
Item# **0000SE0204UA** ●
Item# **0000SE0204UB** ●
Item# **0000SE0204UC** ●
Item# **0000SE0204UF** ●



PPE Storage Bin
1 gallon w/removable, hinged lid, gray, blue handle. Fits in Equodose frame. External dimensions: 6.5"W x 8.5"L x 8.5"H. Internal dimensions: 5.75"W x 7.25"L x 8.0"H
Item# **0000SE3204UA**



5" Side Basket
Item# **P2191102U**



10" Side Basket
Item# **P1191100U**



42" fill hose
Item# **P190010E**



Mop Frame Holder, base mounted
Item# **P1909948U**



Bracket to lock TWICE on Alpha Workstation
Item# **R1800050**



Collection bag, 32 gal. w/grommets, zipper
Item# **0000AT0180U**

PRODUCT DETAILS

EQUODOSE® MOBILE MICROFIBER CHARGING SYSTEM



Equodose Microfiber Charging System complete, 1 tank 1.5 gal
Item# **P311100UA**
With viton rubber parts
Item# **P321101UA**



Equodose Microfiber Charging System complete, 2 tank 1.5 gal each
Item# **P311200UA**
With viton rubber parts
Item# **P321201UA**



Equodose single tank 1.5 gal, blue locking cap
EPDM tank
Item# **P210017TA**
VITON-B tank
Item# **P210022TA**



Equodose single tank 1.5 gal, gray locking cap
EPDM tank
Item# **P210001TU**
VITON-B tank
Item# **P210022TU**

KEY MANAGEMENT SYSTEM



Ergonomic Universal Co-polymer locking key
Item# **P110014U**



Standard Universal Co-polymer Key
Item# **P1909918U** (w/tabs)
Item# **P1909916Q** (no tabs - pictured)



Key Management Complete Sets:
1 lanyard, 1 retractable key ring,
5 Standard Universal locking keys
without tabs
Item# **0000SM00633** (pictured)

1 retractable key ring, 5 Standard
Universal locking keys without tabs
Item# **0000SM00634**

TOP-DOWN® MULTI-MOP CHARGING BUCKET SYSTEM

Complete system



16" Top-Down microfiber charging system complete, bucket 5.0 gal blue, gray hermetic cover & divider
Item# **SE1322AA**

Charging buckets



16" Top-Down charging bucket 2.5 gal blue, gray handle & hermetic cover
Item# **0000SE1310A**



16" Top-Down charging bucket 5.0 gal., gray handle & hermetic cover
Item# **0000SE1322A** ●
Item# **0000SE1322B** ●



12" Top-Down charging bucket 2 gal., gray handle & hermetic cover
Item# **0000SE1308A** ●
Item# **0000SE1308B** ●



Gray hermetic cover for Top-Down charging buckets 2.5 gal and 5.0 gal
Item# **0000CP1108E** 12"
Item# **0000CP1122E** 16"



Rapido Velcro system mop divider for Top-Down charging bucket 5.0 gal, gray
Item# **P190350E**



24" Top-Down charging bucket 3.5 gal., gray handle & hermetic cover
Item# **0000SE1314A** ●

ACCESSORIES



Floor safety sign: 22" Wet Floor sign, 2 parts, yellow
Item# **8614**



Mesh laundry bag, polyester w/drawstring closure, natural, 18.5 gal
Item# **0000AT0104D**



Grabber/Picker: Aluminum grabber/picker, gray w/ ergo handle blue
Item# **9121** 16"
Item# **9122** 40"



Floor squeegee w/ black foam rubber blades
Item# **9011** 14"
Item# **9012** 18"
Item# **9013** 22"
Item# **9014** 30"



4" Wide Floor Scraper
Item# **9152** 10" length
Item# **9013** 47" length

Floor scraper replacement blades - 4" (250/case)
Item# **9154**

PRODUCT DETAILS

MOP HOLDERS AND MICROFIBER MOP HEADS

MOP HOLDERS



16" Uniko Pocket mop holder, blue
w/locking connector
Item# **8432AB**
w/clip and locking connector (pictured)
Item# **0001TD0320AB**



16" Velcro system mop holder blue
w/ locking connector
Item# **5359A**



16" Spin-N-Drop folding system mop holder, blue
w/ locking connector,
2 locking pins
Item# **00018316AB**



18" Velcro system mop holder, Aluminum
w/ locking connector
Item# **0000TA0346A**



Velcro System Dustmop Holder Frame w/ locking connector
Item# **5360A** 24"
Item# **5378A** 32"
Item# **5379A** 40"

POCKET Mop Options

RAPIDO™



- Item# **6090311DA** 16" ○ □
- Item# **6090311AA** 16" ● □
- Item# **6090311BB** 16" ● □
- Item# **6090311CC** 16" ● □
- Item# **6090311DD** 16" ● □

MICRO-FAST



- Item# **0000PN04014A** 16" ● □
- Item# **0000PN04014B** 16" ● □
- Item# **0000PN04014C** 16" ● □
- Item# **0000PN04014F** 16" ● □
- Item# **0000PN04014** 16" ● □

MICRO-KLEEN



- Item# **0000PN04025D** 16" ● □

MICRO-ACTIVA



- Item# **0000PN04012** 16" ● □

VELCRO Mop Options

RAPIDO™



- Item# **6090114DA** 16" ○ □
- Item# **6090114AA** 16" ● □
- Item# **6090114BB** 16" ● □
- Item# **6090114CC** 16" ● □
- Item# **6090114FF** 16" ● □

MICRO-FAST



- Item# **0000PN03014A** 16" ● □
- Item# **0000PN03014B** 16" ● □
- Item# **0000PN03014C** 16" ● □
- Item# **0000PN03014F** 16" ● □
- Item# **0000PN03014** 16" ● □

MICRO-KLEEN



- Item# **0000PN03025A** 16" ● □

MICRO-ACTIVA



- Item# **0000PN03012** 16" ● □

TAB Mop Options

RAPIDO™



- Item# **6090121D** 16" ○ □
- Item# **6090121AA** 16" ● □
- Item# **6090121BB** 16" ● □
- Item# **6090121CC** 16" ● □
- Item# **6090121FF** 16" ● □

MICRO-FAST



- Item# **0000PN07014A** 16" ● □
- Item# **0000PN07014B** 16" ● □
- Item# **0000PN07014C** 16" ● □
- Item# **0000PN07014F** 16" ● □
- Item# **0000PN07014** 16" ● □

MICRO-ACTIVA



- Item# **0000PN07012** 16" ● □

PULI-SCRUB



- Item# **0000PN07011** 16" ● □

MCP



Microfiber-Cotton-Polyester mop with tabs
Item# **6090122D** 16" ● □

LONG LENGTH Mop Options



Rapidop Velcro microfiber twist loop mop heads

- Item# **6090115AA** 24" ●
- Item# **6090116AA** 34" ●
- Item# **6090117AA** 42" ●
- Item# **6090115DA** 24" ○
- Item# **6090116DA** 34" ○
- Item# **6090117DA** 42" ○



Velcro Micro-Fast microfiber twist loop mop heads

- Item# **0000PN03024** 24" ●
- Item# **0000PN08014** 34" ●
- Item# **0000PN01014** 42" ●

PRODUCT DETAILS

DISPOSABLES

QUIK-STIK DUSTING SLEEVE



Quik-Stik Disposable Dusting Sleeve, white

Item# **00PU0102000** 18"
Item# **00PU0102001** 24"

QUIK-STIK DUSTING WIPES



Quik-Stik Disposable Daily Dusting Wipes, 200 pre-cut sheets of 6" x 8" per roll; 8 rolls
Item# **00PU0101000**

MONO-MICRO PE100 MOPS



Mono-Micro PE100 Disposable Microfiber Mop 100% Polyester (PE) Microfiber, .5 denier, on both sides. 4-5 oz. chemical absorbency. 18.5" x 5.5". Velcro system.
Item# **0001PN02142** (10 bags/50 mops per bag)
Item# **0B01PN02142** (1 bag/50 mops)

DRY-UP ABSORPTION PAD



Dry-Up Disposable Absorption Pads, .25 gallon absorbency 17 3/4" L x 13" W
Item# **0000PN02069**
10 pads/bag (5 bags/case)

MONO-WIPE TNT50 CLOTH WIPES



MONO-WIPE TNT50 Dry Disposable Cloth-Wipes. Non-woven, 65% rayon, 35% polyester. Pulls from center. 11" x 12.5". Wipes folded in half for packaging; roll 7.87" x 5.3" x 5.5". 6 rolls/case. 90 wipes per roll = 540 wipes per case).
Item# **00PU0203000**

DISPOSABLE WIPE DISPENSER



Disposable Wipe Dispenser (for charging or dispensing disposable wipes. Heavy-duty, one (1) gallon. Reusable. Co-polymer with Slide-n-Seal dispensing opening. Internal dimensions: 4.7"W x 7.85"L x 7.85"H. External dimensions: 5"W x 8"L x 8"H.
Item# **0000SE3104A**

DISPOSABLE STRING MOP



Disposable String Mop. Polyester & cellulose blend. 16" length. Weighs 9 oz. Absorbs up to 5 times its weight.
Item# **6201D** 50 mops/case

LAMELLO RUBBER BLADE DISPOSABLE FLOOR DUSTING



LaMello Rubber Blade Duster with locking connector
Item# **73000A** 16"
Item# **73001A** 24"
Item# **73002A** 32"



38"- 72" Aluminum telescopic pole/handle w/rubber top, blue
Item# **0000AM3070UA**



Quik-Stik Disposable Daily Dusting Wipes, 200 pre-cut/perforated sheets of 6" x 8" per roll; 8 rolls.
Item# **00PU0101000**

BRILLIANT SURFACE CLEANING SYSTEM (GLASS, STAINLESS STEEL, LAMINATES)

Special Retail Packaging

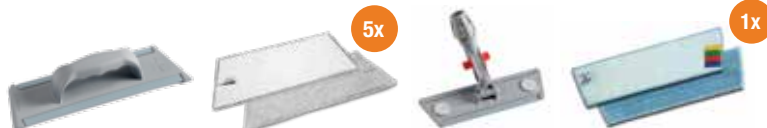

SUPER GLASS CLEANING KIT BRILLIANT
12" Hand trowel, 12" Pad holder w/ locking connector; 5-12" Brilliant Ultra Microfiber pads; 1-12" Micro-Activa mop head, 22"- 36" aluminum telescopic pole
Item# **0000SM00621**

Special Retail Packaging

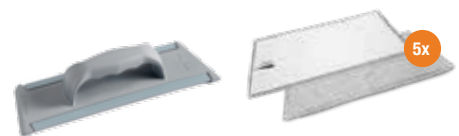

GLASS CLEANING KIT BRILLIANT
12" Hand trowel, 5- Brilliant Ultra Microfiber pads
Item# **0000SM00619**

PRODUCT DETAILS

TOTAL MOP BUCKETLESS MOPPING SYSTEM

QUICK CHANGE MOP SYSTEM



Total Mop bucketless cleaning system complete blue with 22 oz. removable, quick change tank

VELCRO

SIDE DISPENSING:
Item# **0000TD0141A** 12"
Item# **0000TD0151A** 16"

TOP DISPENSING:
Item# **0000TD0051A** 16"

POCKET

SIDE DISPENSING POCKET:
Item# **0000TD0195A** 16"

TOP DISPENSING POCKET:
Item# **0000TD0095A** 16"



ON-BOARD MOP SYSTEM



Total Mop bucketless cleaning system complete blue

- 50 oz. tank
- Top dispensing knob
- Velcro system

Item# **OPR18248** 16"



SPRINTER FILL 'N FLOW HANDLE



Fill 'n Flow dispensing handle
- 17 oz. capacity
- TOP dispensing knob
- Velcro mop holder

Item # **0000TD0451A** 16"



Velcro Rapido



Item# **6090113DA** 12" ○ ■
Item# **6090114DA** 16" ○ ■

Velcro Micro-Fast



Item# **0000PN02014** 12" ○ ■
Item# **0000PN03014** 16" ○ ■

Velcro Micro-Activa



Item# **0000PN02012** 12" ● ■
Item# **0000PN03012** 16" ● ■

Pocket Rapido



Item# **6090311D** 16" ○ □

Pocket Micro-Fast



Item# **0000PN04014** 16" ○ ■

Pocket Micro-Activa



Item# **0000PN04012** 16" ● ■

TOTAL MOP® Accessories

Color-coded solution containers



22 oz. solution tank, quick change
Item# **P291029A** ●
Item# **P291029B** ●
Item# **P291029C** ●
Item# **P291029F** ●



34 oz. solution tank, quick change
Item# **P291030A** ●
Item# **P291030B** ●
Item# **P291030C** ●
Item# **P291030F** ●



Transportation Caddy for 6 gal solution tanks, dark gray
Item# **3691U**



UNI-Move Tool Hanger
Item# **0000SM00250U**



16" Silicon tube for total mop bucketless cleaning system, clear
Item# **P191021T**

PRODUCT DETAILS

V-SWEEPER® Large Area Floor Dusting System



58" V-SWEEPER COMPLETE

RAPIDO

Item# **5201AA/SY** ● 58" full open width

Item# **5201DA/SY** ○ 58" full open width

MICRO-FAST

Item# **5201MF/SY** ● 58" full open width

72" V-SWEEPER COMPLETE

RAPIDO

Item# **5203AA/SY** ● 72" full open width

Item# **5203DA/SY** ○ 72" full open width

MICRO-FAST

Item# **5203MF/SY** ● 72" full open width



V-Sweeper Rapido

Microfiber twist loop mop head

Item# **6090116AA** 34" ●

Item# **6090117AA** 42" ●

Item# **6090116DA** 34" ○

Item# **6090117DA** 42" ○

V-Sweeper Micro-Fast

Microfiber twist loop mop

Item# **0000PN08014** 34" ●

Item# **0000PN01014** 42" ●

V-Sweeper Velcro Frame

Item# **5201/28A** 58" open width

Item# **5201/21A** 72" open width

V-Sweeper handle

Item# **5202**

MICROFIBER VELCRO DUSTING HOLDERS/MOPS

STANDARD CONNECTOR



Velcro System Dustmop Holder Frame
(standard connector)

Item# **5260A** 24"

Item# **5278A** 32"

Item# **5279A** 40"

LOCKING CONNECTOR



Velcro System Dustmop Holder
Frame with locking connector

Item# **5360A** 24"

Item# **5378A** 32"

Item# **5379A** 40"

Key Hole Floor Dusting



Item# **0000PN00184** 18" ○

Item# **0000PN00244** 24" ●

Item# **0000PN00364** 36" ●

Item# **0000PN00484** 48" ●

Item# **0000PN00604** 60" ●

Item# **0000PN00724** 72" ●



Velcro **Rapido** microfiber mop

Item# **6090115AA** 24" ●

Item# **6090116AA** 34" ●

Item# **6090117AA** 42" ●

Item# **6090115DA** 24" ○

Item# **6090116DA** 34" ○

Item# **6090117DA** 42" ○

Velcro **Micro-Fast** microfiber mop

Item# **0000PN03024** 24" ●

Item# **0000PN08014** 34" ●

Item# **0000PN01014** 42" ●

PRODUCT DETAILS

HAND TROWEL SURFACE CLEANING SYSTEM



Hand trowel Velcro System,
gray
Item# **5233U** 12"
Item# **5234U** 16"



Rapido long loop
microfiber pad
Item# **6090113DA** 12" ○ ■
Item# **6090114DA** 16" ○ ■



Micro-Fast long loop
microfiber pad
Item# **0000PN02014** 12" ● ■
Item# **0000PN03014** 16" ● ■



Micro-Activa short loop
microfiber pad
Item# **0000PN02012** 12" ● ■
Item# **0000PN03012** 16" ● ■



Top-Down Charging Bucket
2 gallon - 12"
Item# **0000SE1308A** ●
Item# **0000SE1308B** ●



12" Hermetic Cover for Top-Down
Charging Bucket
Item# **0000CP1108E**



Top-Down Charging Bucket
2.5 gallon - 16"
Item# **0000SE1310A** ●



Grey hermetic cover for
Top-Down charging buckets
2.5 gal and 5.0 gal
Item# **0000CP1122E**



Two-sectioned tray with long
handle & insert for holding 3
bottles, gray.
Item# **3690U**

MICROFIBER CLOTHS



16" x 16" Microfiber Cleaning Cloth
16 fold, 200 washings
Item# **B0052-200** ●
Item# **B0062-200** ●
Item# **B0072-200** ●
Item# **B0082-200** ●



Microfiber Cloth Charging Bucket,
1 gallon, colored handles
Item# **0000SE0204UA** ●
Item# **0000SE0204UB** ●
Item# **0000SE0204UC** ●
Item# **0000SE0204UF** ●



Hinged lid for 1 gallon Microfiber
Cloth Charging Bucket
Item# **0000CP1205T**

PRODUCT DETAILS

SPILLO FLEX SPINE Dusting System



16" Spillo Flex Spine Dusting Kit with 16" flex spine frame, pole adaptor, Micro-Fast sleeve
 Kit with 39" handle
 Item# **1460UDK01**
 Kit w/ 38"-72" Telescopic pole
 Item# **1460UDK02**



Spillo Hand Duster frame, blue
 Item# **1460U** 16"
 Item# **1600A** 24"



16" Spillo Flex Spine Dusting Kit (Basic) 16" flex spine frame, 38"-72" Telescopic pole, pole adaptor
 Item# **1460U02**



Quik-Stik Disposable Dusting Sleeve, white
 Item# **00PU0102000** 18"
 Item# **00PU0102001** 24"



Microfiber long shag dusting sleeve, white/purple
 Item# **1086DK** 16" ●
 Item# **2086DK** 24" ●



Pole adaptor for Spillo hand duster
 Item# **P179041A**

SNAKE BEND SPINE Dusting System

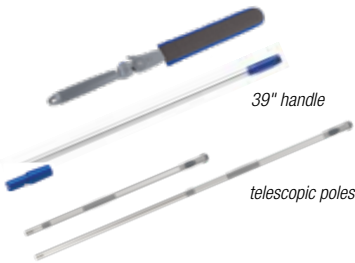

16" Snake Bend Spine Dusting Kit: 16" bendable spine frame, pole adaptor and pole choice:
 Kit with 39" handle
 Item# **2450A04**
 Kit w/ 38"-72" Telescopic pole
 Item# **2450A05**
 Kit w/ 22"-36" Telescopic pole
 Item# **2450A06**

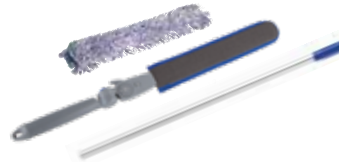

Snake Bend Spine Dusting Kit: 16" Snake frame, Micro-Fast sleeve
 Kit w/ 39" handle
 Item# **2450ADK04**
 Kit w/ 38"-72" Telescopic pole
 Item# **2450ADK05**
 24" Snake frame, Micro-Fast sleeve
 Kit w/ 39" handle
 Item# **1650ADK01**

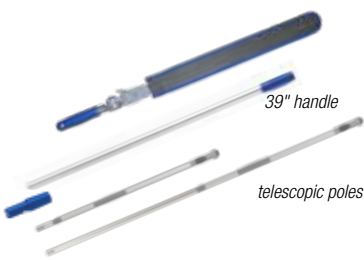

24" Snake Bend Spine Dusting Kit: 24" bendable spine frame, pole adaptor with pole choice:
 Kit with 39" handle
 Item# **1650A01**
 Kit w/ 38"-72" Telescopic pole
 Item# **1650A02**
 Kit w/ 22"-36" Telescopic pole
 Item# **1650A03**



Quik-Stik Disposable Dusting Sleeve, white
 Item# **00PU0102000** 18"
 Item# **00PU0102001** 24"



Microfiber long shag dusting sleeve, white/purple
 Item# **1086DK** 16" ●
 Item# **2086DK** 24" ●



Pole adaptor for Snake hand duster
 Item# **P179041A** 24"

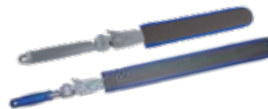

Snake Bend Spine Duster, star-keeper and hook
 Item# **2450A** 16"
 Item# **1650A** 24"

PRODUCT DETAILS

BAGGY & JOBBY FLOOR COLLECTION

BAGGY COLLECTION SYSTEM



BAGGY Collection System Complete: Ergo foldable handle bag holder, squeegee, 10 bags
 Item# **0000PA20400**
 Item# **0000PA20400-12**
(order multiples of 12 units)



11.5" Baggy collection system bag holder
(Ergo foldable handle)
 Item# **0000PA10400**



11.5" Replacement rubber for Baggy collection holder
 Item# **P190501H**

JOBBY COLLECTION SYSTEM



JOBBY Collection System Complete; Ergo foldable handle, dust pan & squeegee
 Item# **000020404U**
 Item# **000020404U-12**
(order multiples of 12 units)



12.5" Collection System squeegee
 Item# **0000SC10200**
 Replacement Rubber
 Item# **0000SC00200**
 Replacement handle
 Item# **TA22085**



10.5" Replacement rubber for Jobby collection pan
 Item# **60196**



8" Broom for Jobby
 Item# **0000SC1010H**

DELTA MULTI-COLLECTION HAMPERS



DELTA COLLECTION FRAME KIT:
 White co-polymer plastic frame with 4 swivel wheels, foot pedal and colored cover of choice. Two stationary front feet included for optional use.

Item# **0000C04120U** gray
 Item# **0000C04121U** blue
 Item# **0000C04122U** red
 Item# **0000C04123U** yellow
 Item# **0000C04124U** green



Includes two stationary feet for a semi-mobile version



Co-polymer cover

Item# **P290976U** gray
 Item# **P290976A** blue
 Item# **P290976B** red
 Item# **P290976C** yellow
 Item# **P290976F** green

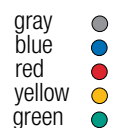

Coated, washable, reusable 32 gallon bag. Gray. Can be lined with secondary bag (disposable or linen)
 Item# **0000AT0190E** gray



Carry-All basket (co-polymer) for holding extra bags, cleaning supplies, etc.
 Item# **P190975N**



Hydraulic, shock absorbing piston for silent cover closing
 Item# **P190908U**

POLARIS 24-GALLON STEP-ON TRASH BIN



POLARIS BASIC TRASH BIN
 Co-polymer 24 gallon capacity bin with two 4" wheels, foot pedal, and a choice of cover colors. 20.4" W x 19" L x 36.4" H

Item# **0000C02090i** beige
 Item# **0000C02091i** blue
 Item# **0000C02092i** red
 Item# **0000C02093i** yellow
 Item# **0000C02094i** green



POLARIS DELUXE TRASH BIN
 Co-polymer 24 gallon capacity bin with latched front panel, single bag frame, Tuck-n-Snap Bag Holding System, two 4" wheels, foot pedal, and a choice of cover colors. 20.4" W x 19.2" L x 36.4" H

Item# **0000C03090i** beige
 Item# **0000C03091i** blue
 Item# **0000C03092i** red
 Item# **0000C03093i** yellow
 Item# **0000C03094i** green

PRODUCT DETAILS

FLOOR FINISHING



Press Mop Wring System Set Complete
Includes: 7 gal. bucket (20.5"), sieve, cover & casters.
 Item# **0030SE1528A**



16" Total Mop Bucketless Floor Finishing System with on-board container & top dispensing knob
 Item# **60818148**



Bucket & Sieve only
 Item# **0010SE1428A**

Bucket, Sieve & Cover
 Item# **0010SE1528A**

Bucket, Sieve, Casters
 Item# **0030SE1428A**



16" Floor Finish Mop Holder
 Item# **0000TA0001A**



18" Floor Finishing Pad (microfiber/acrylic) 5.5" width, green
 Item# **8139**



17.5" Micro-Fast twist loop mop, velcro. 4.3 oz, 4-color tag
 Item# **0000PN03014**



18" Protective Pocket Bag prevents dripping/ dry-out of mop during usage
 Item# **Q0400119E**



20.5" press mop bucket
 Item# **0000SE1428A** ●
 Item# **0000SE1428B** ●



Cover, 20.5" bucket
 Item# **0000CP1128E**



Sieve, 20.5" bucket
 Item# **P1190043A**



2" diameter casters, 20.5" bucket
 Item# **7949**

UNI-TAB PRO QUICK RELEASE MOP SYSTEM

STANDARD UNI-TAB PRO STARTER KIT

Item# **K001TP0306AU**



38" - 72" Aluminum Telescopic Handle



Uni-Tab Pro Mop Holder w/locking connector



Uni-Tab Rapido, blue Microfiber Mop Head



Uni-Tab Pro Mop Holder w/locking connector
 Item# **0000TP0306AU**



18" Uni-Tab Rapido, blue Microfiber Mop Head
 Item# **18FC0402i00A**



Uni-Tab Micro-Activa Microfiber Mop Head
 Item# **00PN0404i00**



38"-72" Aluminum telescopic pole/handle gray
 Item# **0000AM3070UA**

PRODUCT DETAILS

ERGOSWING Ergonomic Flat-Mop System



ErgoSwing Aluminum Telescopic Handle. Length adjusts from 41.5" to 73.5".
Item# **0000AM3045A**



16" Spin-n-Drop Tab Holder w/ ErgoSwing Connector
Item# **00008916AB**



16" Uniko Pocket Holder w/ ErgoSwing Connector
Item# **0000TD0920AB**



18" Aluminum Velcro Holder w/ ErgoSwing Connector
Item# **0000TA0946A**



Velcro Holder w/ ErgoSwing Connector
Item# **5959A** 16"
Item# **5960A** 24"



LaMello Duster w/ ErgoSwing Connector
Item# **79000A** 16"
Item# **79001A** 24"

POLES & HANDLES



22" - 36" Aluminum telescopic handle w/ central grip & hole, gray handle, gray rubber top
Item# **0000AM3090A**



32" - 55" Aluminum telescopic handle w/ central grip & hole, gray handle, blue rubber top
Item# **0000AM03075UA**



38"-72" Aluminum telescopic pole/handle gray
Item# **0000AM3070UU** ● rubber top
Item# **0000AM3070UA** ● rubber top
Item# **0000AM3070UB** ● rubber top
Item# **0000AM3070UC** ● rubber top
Item# **0000AM3070UF** ● rubber top



39" Aluminum extension handle
Item# **0000AM0003A**



55" Aluminum extension handle w/ hole, .90" diameter
Item# **0000AM30015**



57" Fiberglass pole/handle, .90" diameter, MRI-safe
Item# **1069E**



UNI-Move Tool Hanger
Item# **0000SM00250U**

TABLE OF CONTENTS

About Filmop	2	Disposables	20
Filmop Advantage	3	Mono-Wipe TNT50, Dry-Up, String Mop, Quik-Stik,	
Facility Cleaning Program Overview.....	4	Mono-Micro PE100	
Customizable Alpha Facility Workstations	6	Surface & High Level Cleaning: Snake, Spillo	22
Workstations: Parts & Expandability.....	8	Floor Collection Systems: Baggy, Jobby	23
Workstation Security	9	Collection Systems: Delta, Polaris.....	24
Wring Mop System: WRINGERS.....	10	DETAILS: Workstations-Charging	25
Wring Mop System: TWICE Bucket	11	DETAILS: Workstations-Bases	26
Wring Mop System: ALPHA Bucket.....	11	DETAILS: Workstations-Wringing	27
Wring Mop System: OneFRED Bucket.....	12	DETAILS: Bucket Systems	28
Charge Mop Systems: EQUODOSE® & TOP-DOWN®	13	DETAILS: Workstation Accessories	29
Specialty Mops: ErgoSwing, Uni-Tab, Microplast.....	14	DETAILS: Charging Systems & Accessories	30
Mop Model Options: Tab, Pocket, Velcro, String	15	DETAILS: Mop Holders & Mop Heads.....	31
Mop Head Options	16-17	DETAILS: Disposables, LaMello, Brilliant.....	32
Floor Dusting:	17	DETAILS: Total Mop	33
V-Sweeper, LaMello, Wide-Width		DETAILS: Floor Dusting: V-Sweeper & Wide Width	34
Total Mop Bucketless	18	DETAILS: Surface Cleaning: Hand Trowel & Cloths	35
Floor Finishing System	18	DETAILS: High Dusting: Spillo & Snake	36
Surface Cleaning:	19	DETAILS: Floor Collection, Delta, Polaris.....	37
Brilliant Glass/Shiny Surface, Hand Trowel, Cloths		DETAILS: Floor Finishing & Uni-Tab.....	38
		DETAILS: Poles & Handles: ErgoSwing, Aluminum	39



FILMOP® USA LLC.
13410 Highway 105 West
Conroe, Texas 77304
Toll-Free: 888 741 0707
e-mail: info@filmopusa.com
www.FilmopUSA.com